



# LM105/LM205/LM305/LM305A, LM376 Voltage Regulators

## General Description

The LM105 series are positive voltage regulators similar to the LM100, except that an extra gain stage has been added for improved regulation. A redesign of the biasing circuitry removes any minimum load current requirement and at the same time reduces standby current drain, permitting higher voltage operation. They are direct, plug-in replacements for the LM100 in both linear and switching regulator circuits with output voltages greater than 4.5V. Important characteristics of the circuits are:

- Output voltage adjustable from 4.5V to 40V
- Output currents in excess of 10A possible by adding external transistors
- Load regulation better than 0.1%, full load with current limiting

- DC line regulation guaranteed at 0.03%/V
- Ripple rejection on 0.01%V
- 45 mA output current without external pass transistor (LM305A)

Like the LM100, they also feature fast response to both load and line transients, freedom from oscillations with varying resistive and reactive loads and the ability to start reliably on any load within rating. The circuits are built on a single silicon chip and are supplied in either a TO-99 metal can or an 8-lead dual-in-line package (as LM376N).

The LM105 is specified for operation for  $-55^{\circ}\text{C} \leq T_A \leq +125^{\circ}\text{C}$ , the LM205 is specified for  $-25^{\circ}\text{C} \leq T_A \leq +85^{\circ}\text{C}$ , and the LM305/LM305A, LM376 is specified for  $0^{\circ}\text{C} \leq T_A \leq +70^{\circ}\text{C}$ .

## Schematic and Connection Diagrams

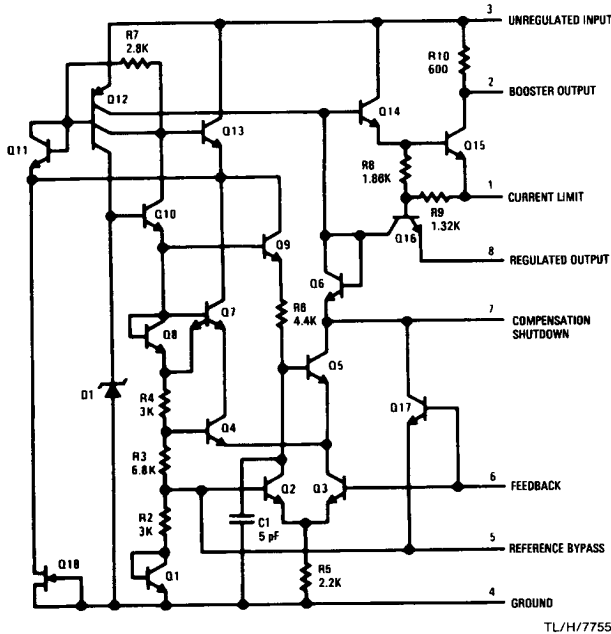

Pin connections shown are for metal can.

TL/H/7755-1

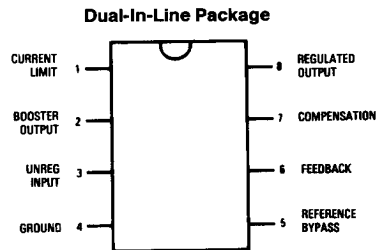

TL/H/7755-2

### Top View

Order Number LM376N  
See NS Package Number N08E

### Metal Can Package

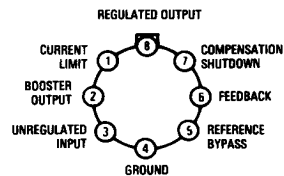

TL/H/7755-3

### Top View

Order Number LM105H,  
LM205H, LM305H or LM305AH  
See NS Package Number H08C

## Absolute Maximum Ratings

If Military/Aerospace specified devices are required, please contact the National Semiconductor Sales Office/Distributors for availability and specifications. (Note 5)

	LM105	LM205	LM305	LM305A	LM376
Input Voltage	50V	50V	40V	50V	40V
Input-Output Differential	40V	40V	40V	40V	40V
Power Dissipation (Note 1)	800 mW	800 mW	800 mW	800 mW	400 mW
Operating Temperature Range	-55°C to +125°C	-25°C to +85°C	-0°C to +70°C	0°C to +70°C	0°C to +70°C
Storage Temperature Range	-65°C to +150°C	-65°C to +150°C	-65°C to +150°C	-65°C to +150°C	-65°C to +150°C
Lead Temperature (Soldering, 10 seconds)	300°C	300°C	300°C	300°C	260°C

## Electrical Characteristics (Note 2)

Parameter	Conditions	LM105		LM205		LM305		LM305A		LM376		Units
		Min	Max	Min	Max	Min	Max	Min	Max	Min	Max	
Input Voltage Range		8.5	50	8.5	50	8.5	40	8.5	50	9.0	40	V
Output Voltage Range		4.5	40	4.5	40	4.5	30	4.5	40	5.0	37	V
Input-Output Voltage Differential		3.0	30	3.0	30	3.0	30	3.0	30	3.0	30	V
Load Regulation (Note 3)	$R_{SC} = 10\Omega, T_A = 25^\circ\text{C}$	0.02	0.05	0.02	0.05	0.02	0.05					%
	$R_{SC} = 10\Omega, T_A = T_{A(\text{MAX})}$	0.03	0.1	0.03	0.1	0.03	0.1					%
	$R_{SC} = 10\Omega, T_A = T_{A(\text{MIN})}$	0.03	0.1	0.03	0.1	0.03	0.1					%
Line Regulation	$0 \leq I_O \leq 12 \text{ mA}$											
	$0 \leq I_O \leq 12 \text{ mA}$											
	$0 \leq I_O \leq 12 \text{ mA}$											
Temperature Stability	$T_A = 25^\circ\text{C}$											%/V
	$0^\circ\text{C} \leq T_A \leq +70^\circ\text{C}$											%/V
	$V_{IN} - V_{OUT} \leq 5V, T_A = 25^\circ\text{C}$	0.025	0.06	0.025	0.06	0.025	0.06	0.025	0.06	0.025	0.06	%/V
	$V_{IN} - V_{OUT} \geq 5V, T_A = 25^\circ\text{C}$	0.015	0.03	0.015	0.03	0.015	0.03	0.015	0.03	0.015	0.03	%/V
	$T_{A(\text{MIN})} \leq T_A \leq T_{A(\text{MAX})}$	0.3	1.0	0.3	1.0	0.3	1.0	0.3	1.0	0.3	1.0	%

**Electrical Characteristics** (Note 2) (Continued)

Parameter	Conditions	LM105			LM205			LM305			LM305A			LM376			Units
		Min	Typ	Max	Min	Typ	Max	Min	Typ	Max	Min	Typ	Max	Min	Typ	Max	
Feedback Sense Voltage		1.63	1.7	1.81	1.63	1.7	1.81	1.63	1.7	1.81	1.55	1.7	1.85	1.60	1.72	1.80	V
Output Noise Voltage	10 Hz ≤ f ≤ 10 kHz																
	C <sub>REF</sub> = 0		0.005			0.005			0.005			0.005					%
	C <sub>REF</sub> = 0.1 μF		0.002			0.002			0.002			0.002					%
Standby Current Drain	V <sub>IN</sub> = 30V, T <sub>A</sub> = 25°C															2.5	mA
	V <sub>IN</sub> = 40V								0.8	2.0							mA
	V <sub>IN</sub> = 50V			0.8	2.0							0.8	2.0				mA
Current Limit Sense Voltage	T <sub>A</sub> = 25°C, R <sub>SC</sub> = 10Ω, V <sub>OUT</sub> = 0V, (Note 4)	225	300	375	225	300	375	225	300	375	225	300	375		300		mV
Long Term Stability			0.1			0.1			0.1			0.1					%
Ripple Rejection θ <sub>JA</sub>	C <sub>REF</sub> = 10 μF, f = 120 Hz Epoxy Dual-In-Line Package		0.003			0.003			0.003			0.003			140		%/V °C/W
θ <sub>JA</sub>	TO-5 Board Mount in Still Air		230			230			230			230					°C/W
θ <sub>JA</sub>	TO-5 Board Mount in 400 LF/Min Air Flow		92			92			92			92					°C/W
θ <sub>JC</sub>	TO-5		25			25			25			25					°C/W

**Note 1:** The maximum junction temperature of the LM105 and LM305A is 150°C, the LM205 and LM376 is 100°C, and the LM305 is 85°C. For operation at elevated temperatures, devices in the H08C package must be derated based on a thermal resistance of 168°C/W junction to ambient, or 25°C/W junction to case. For the epoxy dual-in-line package, derating is based on a thermal resistance of 138°C/W junction to ambient. Peak dissipations to 1W are allowable providing the dissipation rating is not exceeded with the power average over a five second interval for the LM105 and LM205, and averaged over a two second interval for the LM305.

**Note 2:** Unless otherwise specified, these specifications apply for temperatures within the operating temperature range, for input and output voltages within the range given, and for a divider impedance seen by the feedback terminal of 2 kΩ. Load and line regulation specifications are for a constant junction temperature. Temperature drift effects must be taken into account separately when the unit is operating under conditions of high dissipation.

**Note 3:** The output currents given, as well as the load regulation, can be increased by the addition of external transistors. The improvement factor will be roughly equal to the composite current gain of the added transistors.

**Note 4:** With no external pass transistor.

**Note 5:** Refer to RETS105X Drawing for military specifications for the LM105.

# Typical Performance Characteristics LM105/LM205/LM305/LM305A

LM105/LM205/LM305/LM305A/LM376

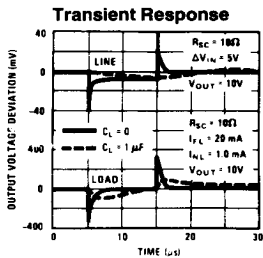
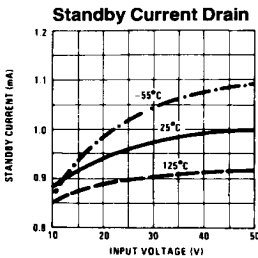
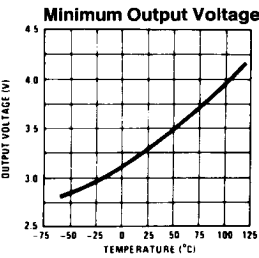
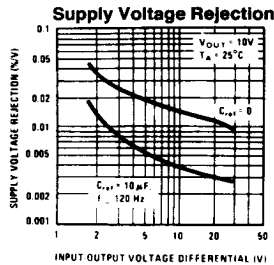
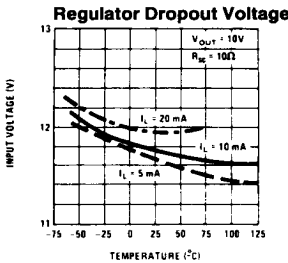
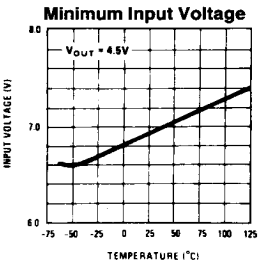
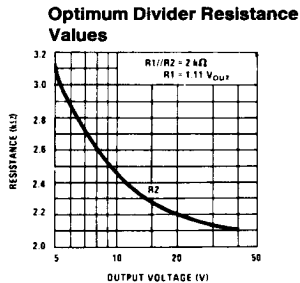
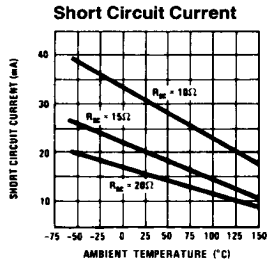
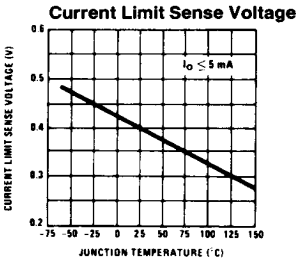
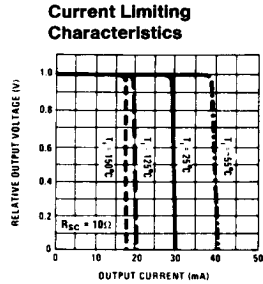
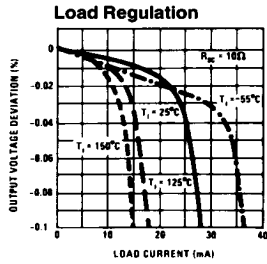
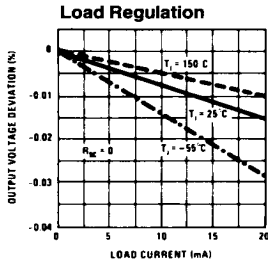

1

TL/H/7755-6

# Typical Performance Characteristics LM376

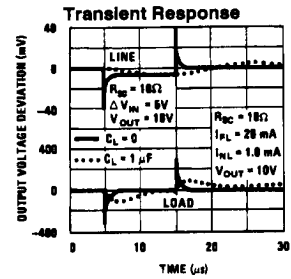
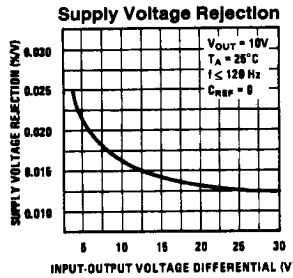
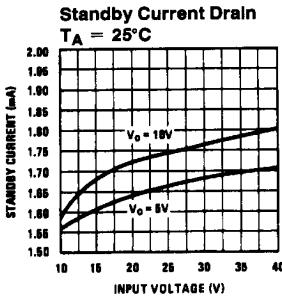
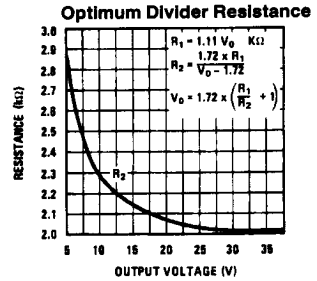
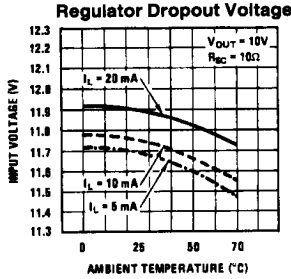
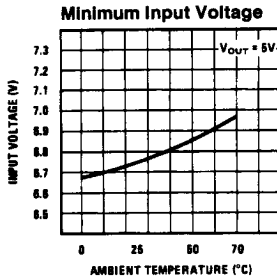
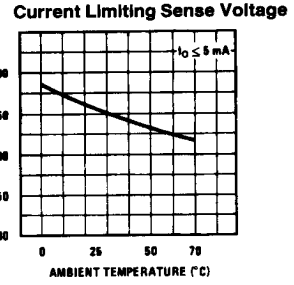
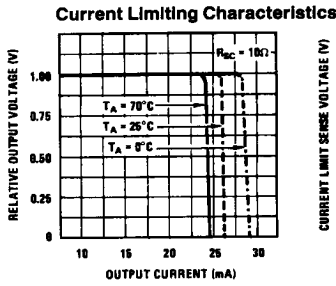
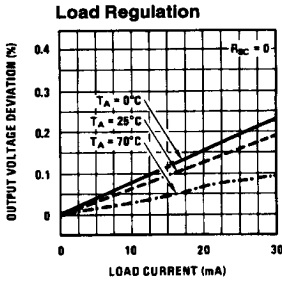

TL/H/7755-7

# Typical Applications

## 10A Regulator with Foldback Current Limiting

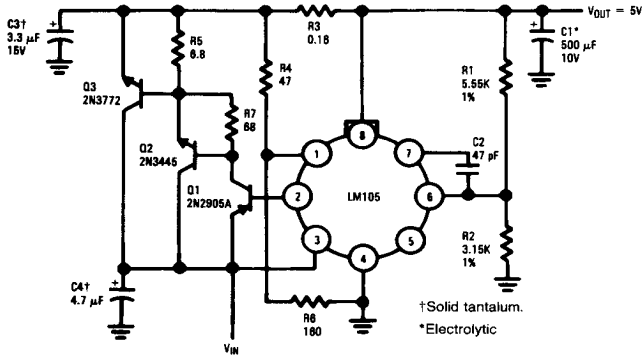

TL/H/7755-4

## 1.0A Regulator with Protective Diodes

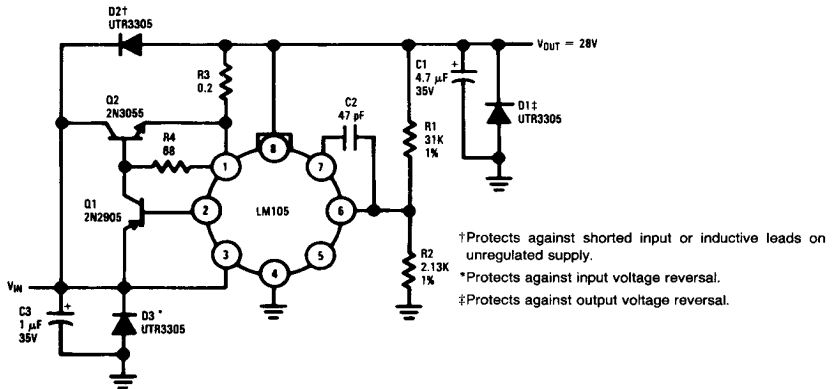

TL/H/7755-5

## Linear Regulator with Foldback Current Limiting

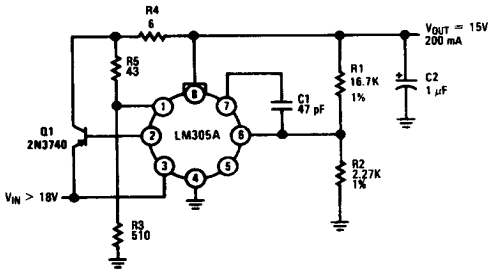

TL/H/7755-8

## Current Regulator

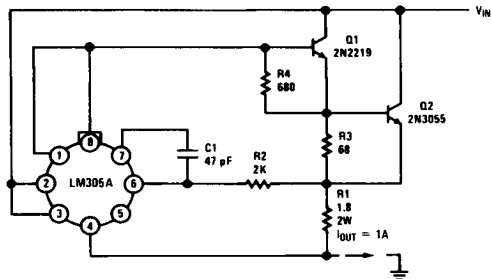

TL/H/7755-9

Typical Applications (Continued)

Shunt Regulator

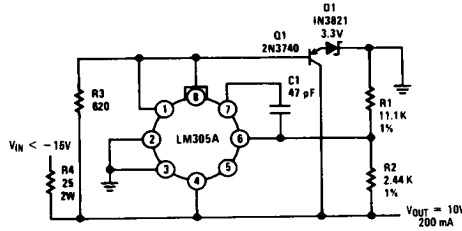

TL/H/7755-10

Switching Regulator

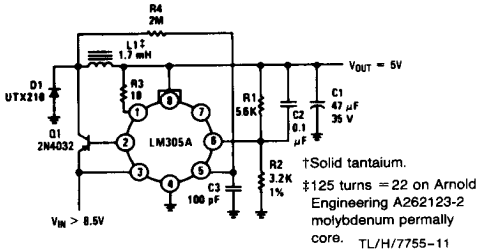

TL/H/7755-11

Basic Positive Regulator with Current Limiting

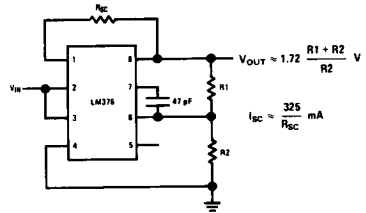

TL/H/7755-12

1.0A Regulator with Protective Diodes

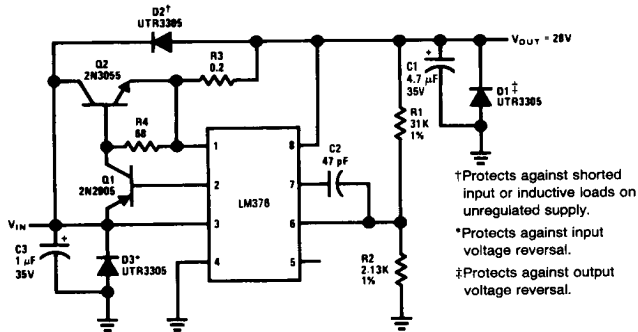

TL/H/7755-13

Linear Regulator with Foldback Current Limiting

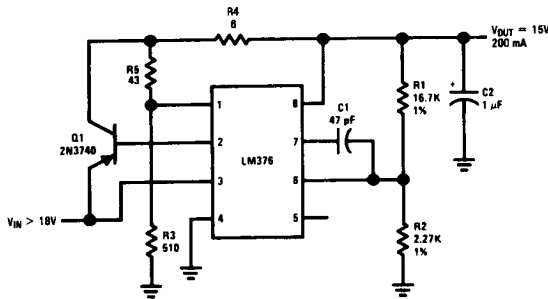

TL/H/7755-14