

MOS INTEGRATED CIRCUIT

M 110

PRELIMINARY DATA

MONOPHONIC SYNTHESIZER

- LOW POWER DISSIPATION < 500 mW TYP.
- N-CHANNEL SILICON GATE PROCESS
- DIGITAL PORTAMENTO EFFECT
- EXTERNAL CONTROL (WITH RC) OF THE PORTAMENTO SPEED IN THE 100 μ s to 150 ms RANGE FOR EACH HALF TONE
- EXTERNAL OSCILLATOR FOR PORTAMENTO (EXT. OSC.)
- STANDARD SUPPLY (12V, GND)
- MATRIX ORGANIZATION 12 x 6 WITH 61 POSITIONS FOR THE KEYBOARD AND 6 COMMANDS
- RESET INPUT FOR FREQUENCY CLAMP
- PRIORITY LEFT OR RIGHT OF THE PRESSED KEYS
- 3 CODED OUTPUTS FOR THE OCTAVE INFORMATION OF THE PLAYING FREQUENCY
- 2 TRIGGER SIGNALS \overline{TP} AND \overline{TS} FOR PERCUSSION AND KEY PRESSED
- 1 OUTPUT WITH DC CURRENT PROPORTIONAL TO THE PLAYING FREQUENCY
- 1 OUTPUT WITH PULSE FOR FALLING EDGE OF THE EXTERNAL SAWTOOTH WAVEFORM (20 μ s)
- SAWTOOTH WAVEFORM SELECTABLE (4', 8', 16', 32')
- PROVISION FOR OBTAINING SAWTOOTH WAVEFORMS WITH FEW EXTERNAL COMPONENTS ON THE 4', 8', 16', 32' FOOTAGES
- 1 OUTPUT WITH FOOT AND DUTY CYCLE ON FOLLOWING COMMANDS
- 4 OUTPUTS WITH 50% DUTY CYCLE (2', 4', 8', 16')

The M110 is realized on a single monolithic silicon chip using low threshold N-channel silicon gate MOS technology. It is available in a 40 lead plastic package.

ABSOLUTE MAXIMUM RATINGS*

V_{DD}^{**}	Supply voltage	-0.3 to 20	V
V_I	Input voltage	-0.3 to 20	V
I_o	Output current (at any output pin)	3	mA
T_{stg}	Storage temperature	-65 to 150	°C
T_{op}	Operating temperature	0 to 50	°C

* Stresses above those listed under "Absolute Maximum Ratings" may cause permanent damage to the device. This is a stress rating only and functional operation of the device at these or any other conditions above those indicated in the operational sections of this specification is not implied. Exposure to absolute maximum rating conditions for extended periods may affect device reliability.

** All voltages are with respect to V_{SS} (GND).

ORDERING NUMBER: M110 B1 for dual in-line plastic package

STATIC ELECTRICAL CHARACTERISTICS ($V_{DD} = 12V \pm 5\%$, $V_{SS} = 0V$, $T_{amb} = 0$ to $50^\circ C$ unless otherwise specified)

Parameter	Test conditions	Min.	Typ.	Max.	Unit
-----------	-----------------	------	------	------	------

CLOCK INPUT (pin 11)

V_{IH}	Clock high voltage	$V_{DD} - 1$		V_{DD}	V
V_{IL}	Clock low voltage	V_{SS}		$V_{SS} + 1$	V

DATA INPUTS (pin 9, 10, 12, 15, 16, 29, 30, 31, 32, 33, 34)

V_{IH}	Input high voltage	$V_{DD} - 2$		V_{DD}	V
V_{IL}	Input low voltage	V_{SS}		$V_{SS} + 2$	V
I_L	Input leakage current	$V_i = 12.6V$ $T_{amb} = 25^\circ C$		10	μA

**DATA OUTPUTS (pin 13, 14, 21, 22, 23, 24, 25, 26, 27, 28)
(2, 3, 4, 5, 6, 7, 35, 36, 37, 38, 39, 40 with external pull-up)**

R_{OUT}	Output res. to V_{SS} Output res. to V_{DD}	for $V_o = V_{DD} - 1$ (driver OFF)		300 15	500 25	Ω $K\Omega$
V_{OH}	Output high voltage		$V_{DD} - 0.4$		V_{DD}	V
V_{OL}	Output low voltage			$V_{SS} + 0.2$	$V_{SS} + 0.4$	V

POWER DISSIPATION

I_{DD}	Supply current	$T_{amb} = 25^\circ C$		30	50	mA
----------	----------------	------------------------	--	----	----	----

INTERNAL OSCILLATOR (pin 8)

RC external	$C = 4.7$ nF $R = 2.2$ M Ω (*) $C = 4.7$ nF $R = 1$ K Ω (*)		0.07 125			KHz
-------------	--	--	-------------	--	--	-----

OUTPUT PULSE 20 μs (pin 20)

V_{OH}	Output high voltage	$I_{OH} = 0$	8	9		V
V_{OL}	Output low voltage	$I_{OL} = 300$ μA	V_{SS}		$V_{SS} + 0.3$	V
R_{OUT}	Output res. to V_{SS} Output res. to V_{DD}	for $V_o = 6V$		0.5 5	1 8	K Ω

(*) Max. admissible value of R = 2.2 M Ω ; min. admissible value of R = 1 K Ω .

DYNAMIC ELECTRICAL CHARACTERISTICS ($V_{DD} = 12V \pm 5\%$, $V_{SS} = 0V$, $T_{amb} = 0$ to $50^\circ C$ unless otherwise specified)

Parameter	Test conditions	Min.	Typ.	Max.	Unit
-----------	-----------------	------	------	------	------

CLOCK INPUT (pin 11)

f_i	Input clock frequency	1600	2000.240	2500	KHz
t_r, t_f	Input clock rise and fall time 10 to 90%			40	ns
t_{on}, t_{off}	Input clock ON and OFF times	2 MHz	200	250	ns

GENERAL CHARACTERISTICS

The circuit includes:

Pin 2, 3, 4, 5, 6, 7, 35, 36, 37, 38, 39, 40

$\bar{F}1$ to $\bar{F}12$: outputs for selection of notes with 22 K Ω external pull-up. The maximum allowable external capacity must be < 500 pF. When not selected these outputs are at the high state (+12V).

Pin 29, 30, 31, 32, 33, 34

$\bar{B}1$ to $\bar{B}6$: inputs for selection of octave with 5.6 K Ω external pull-up so that these are at the high state when not selected.

Pin 12

L/R input for selecting priority to the left or right.

- if priority to the right is selected the note relative to the key farthest to the right of those pressed is supplied at the output
- priority to the left gives the possibility of choosing one key out of the first 12 pressed, starting from the left
- the internal pull-up is between 200 and 350 K Ω .

Pin 15

BC: input for selecting priority key in the case of priority to the left.

Pin 11

Clock: input frequency for generating notes.

(The internal logic of the system provides a precision equal to that of the TOS-M087-M083).

Pin 9, 8

Ex Osc-RC of Clock for portamento:

- an external oscillator with square wave can be connected at the first input (pin 9) limiting the max. frequency to 160 KHz. The duty cycle can be as desired provided that the minimum duration of the "0" and of the "1" is 2 μ s.
- the 2nd input (pin 8) foresees the use of an external RC with the possibility of varying the frequency of the internal oscillator by regulating R.
The maximum frequency value which can be measured on the pin must have a period $T = 6 \mu$ sec. With values of $R = 2.2 M\Omega$ (potentiometer) and $C = 4.7 nF$, we obtain $T_{min} \approx 8 \mu$ s and $T_{max} \approx 14$ ms. The corresponding portamento time between the 2 keys at the two extremes of the keyboard is: min. time ≈ 7 ms, max. time ≈ 12 sec.
- the portamento time between 2 semitones can be defined by applying the following formula:

$$\text{Portamento time} = 16 \times \text{oscillator frequency period}$$

The two oscillators must not be switched on simultaneously; use of one must exclude the other. The pin for the oscillator not in use is connected to V_{SS} .

- The portamento time between 2 keys is proportional to the distance between them; this means that the law of portamento/keys variation is linear.

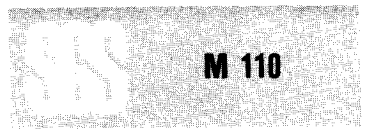

GENERAL CHARACTERISTICS (continued)

Pin 10

Reset Sync.: input required when several SGS-ATES devices are used, all having the same type of scanning, so that only one contact need be used per key. Otherwise it is connected to V_{SS} .

Pin 16

Reset input (active high) active on outputs 2', 4', 8', 16', output with foot duty cycle programmable, output pulse 20 μ s.

Pin 28, 27, 26

OA-OB-OC: used in binary code of the octave to which the note selected belongs. The highest weight code is relative to the lowest octave. The 3 outputs are of the push-pull type.

Pin 25

Output with foot and duty cycle programmable; digital output with possibility of 4 functions: 8', 12.5%, 8' 25%, 16' 6.25%, 16' 12.5%.

Only one function can be selected at a time with the commands inserted in the matrix of the keyboard (push-pull).

Pin 20

Output 20 μ s pulse: output for zeroing the sawtooth whose duration is between 16 and 24 μ s at 2 MHz of clock (push-pull).

Pin 13

\overline{TS} : output of key pressed: high in absence of keys pressed, low in presence of keys pressed (push-pull).

Pin 14

\overline{TP} : output of priority key; high in absence of keys inserted, low in priority conditions (in this case the output goes to zero for a time equal to 8 ± 0.6 ms with clock 2 MHz) (push-pull).

— The conditions required to make a pulse appear at this exit are:

- insertion of at least 1 key
- insertion of a new priority key
- release of a priority key when another key pressed previously acquires priority.

Pin 21, 22, 23, 24

2'-4'-8'-16': square wave outputs (push-pull) with 50% of duty cycle on 4 different footages: 2', 4', 8', 16' corresponding to the following max frequencies: 8372 Hz; 4186 Hz; 2093 Hz; 1046 Hz.

These outputs switch on the rise front.

Pin 19

DC: output which generates a current proportional to the frequency output therefore exponential with the position of the key.

Pin 18

V_{reg} : input necessary for calibration of current (OUT DC) and amplitude of sawtooth for different devices.

GENERAL INFORMATION

- Updating of a key between insertion and relative output information occurs in 0.5 ms.
- On release of all the keys pressed the last key released in order of time is memorized; consequently the relative frequency (on the 4 footages) and current (OUT DC) are memorized at the output.
- Each interval between 2 adjacent semitones is divided into 8 frequencies.
- The ratio between two contiguous frequencies is $\approx \sqrt[96]{2}$.

Binary representation of octave codes

OA	OB	OC	
1	1	1	lowest octave
0	1	1	
1	0	1	
0	0	1	
1	1	0	highest octave
0	1	0	

Function with selectable foot and duty cycle

Selection of one of the 4 possible functions occurs via commands connected to the diode matrix of the keyboard.

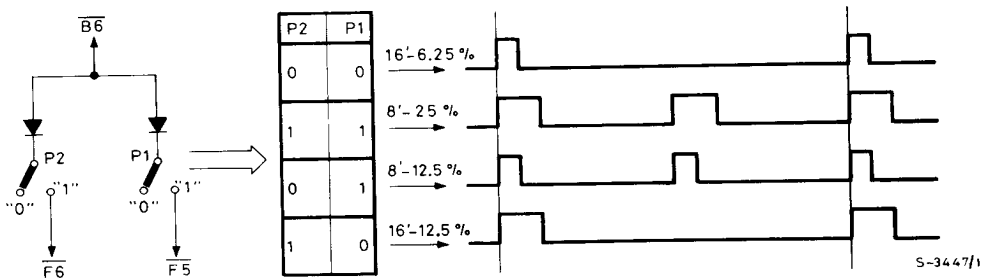

MATRIX ORGANIZATION (Keyboard and controls)

M110 matrix output	M110 Octave bar inputs						Selection for the priority on the left BC
	$\overline{B1}$	$\overline{B2}$	$\overline{B3}$	$\overline{B4}$	$\overline{B5}$	$\overline{B6}$	
$\overline{F1}$	(*) C1	C2	C3	C4	C5	(*) C6	1st key on the left
$\overline{F2}$	C1 #	C2 #	C3 #	C4 #	C5 #		2nd key on the left
$\overline{F3}$	D1	D2	D3	D4	D5		3rd key on the left
$\overline{F4}$	D1 #	D2 #	D3 #	D4 #	D5 #		4th key on the left
$\overline{F5}$	E1	E2	E3	E4	E5	P1 (***)	5th key on the left
$\overline{F6}$	F1	F2	F3	F4	F5	P2 (***)	6th key on the left
$\overline{F7}$	F1 #	F2 #	F3 #	F4 #	F5 #		7th key on the left
$\overline{F8}$	G1	G2	G3	G4	G5		8th key on the left
$\overline{F9}$	G1 #	G2 #	G3 #	G4 #	G5 #	(**) sawtooth 32'	9th key on the left
$\overline{F10}$	A1	A2	A3	A4	A5	(**) sawtooth 16'	10th key on the left
$\overline{F11}$	A1 #	A2 #	A3 #	A4 #	A5 #	(**) sawtooth 8'	11th key on the left
$\overline{F12}$	B1	B2	B3	B4	B5	(**) sawtooth 4'	12th key on the left

(*) C1 is the first key on the left; C6 is the last key on the right of the keyboard.

(**) This control selects the correct pulse of the sawtooth generated by OUT DC (pin n° 19).

(***) P1 and P2 are the controls for the output with foot and duty cycle programmable.

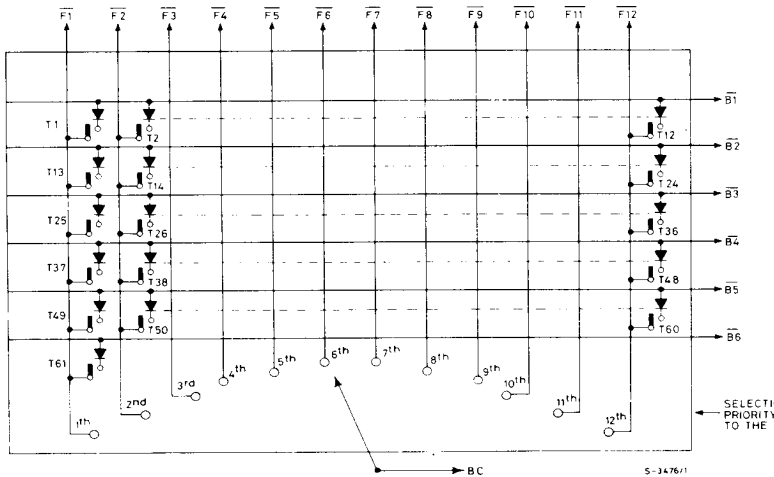
12 x 6 MATRIX

If the device is used with selection of the first key to the left connect the control bar BC to V_{SS} .
For different priorities of the first key to the left connect BC to the selection frequency for the selected priority key. In this case BC must have a pull-up of 5,6 K Ω .

The selection sequence is:

$\overline{F1}$ selects the first key to the left.
:
 $\overline{F12}$ selects the twelfth key to the left.

POWER ON RESET

The device must have an external circuit for the power-on reset (pin 16) high active. In the application diagram a power-on reset time of 0.5 sec is used and the circuit also connects, when active, the B1 bar to V_{SS} .

ANTIBOUNCE CIRCUIT

The antibounce circuit eliminates bounce caused by the contact springs of the keyboard. The bounce may supply wrong information at outputs TS and TP.

The diagram is as follows:

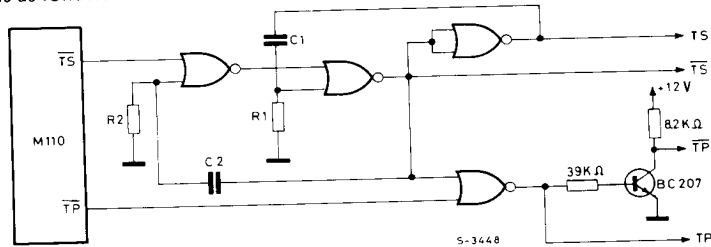

The antibounce time can be regulated by acting on constants R1-C1 (antibounce on pressing a key) and R2-C2 (antibounce on release of key). In the application diagram of the device an antibounce of 18 ms is established $C1 = C2 = 18 \text{ nF}$ and $R1 = R2 = 1 \text{ M}\Omega$. The time constants must not however be 12 ms.

The antibounce circuit supplies the high or low active priority key and key pressed outputs compatible with the technical requirements requested.

GENERATION OF SAWTOOTH

The four sawtooth signals (4', 8', 16', 32' corresponding, for the last key on the right, to 4186 Hz; 2093 Hz, 1046 Hz, 523 Hz) are analog and are obtained by loading (with constant current) and unloading four external capacitors. A current mirror of the type shown below is produced.

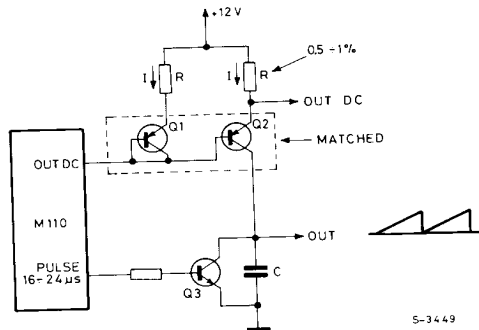

- The reference of the sawtooth is V_{SS} .
- The best results are obtained using T1 and T2 matched with h_{FE} high while resistances R must have 0.5 to 1% precision.
- The maximum variation in the amplitude of the sawtooth (over the whole keyboard) is $\pm 4\%$.

CALIBRATION

- a) Press key 61.
 - b) Regulate V_{reg} until OUT DC is $9V (\pm 3\%)$.
 - c) In these conditions the sawtooth assumes an amplitude of $4V$ and $V_{reg} = 5V \pm 30\%$.
 - d) In these conditions value of R must be 1600Ω .
 - e) The OUT DC voltage must not fall below $9V (\pm 3\%)$; this means that the maximum voltage excursion between the 1st and 61st key is $3V$.
 - f) If OUT DC excursions lower than $3V$ are required for the whole keyboard, the value of R must be reduced in proportion to the new value of OUT DC.
- let us consider some practical values of OUT DC:

OUT DC	R
3 V	1600 Ω
2 V	1066 Ω
1.5 V	800 Ω

values of R proportional to OUT DC

- This rule must be applied to avoid frequency/voltage linearity errors.
- The value of R must be between 100 to 1600 Ω .
- The current/frequency conversion and therefore the variation in amplitude of the sawtooth for the whole keyboard have a precision of 4% .
- When the value of R and the maximum value of OUT DC have been established the latter can be maintained constant for any device simply by acting on V_{reg} .
- The resistive divider from which the V_{reg} is taken should be established respecting the following rules:
 - 1) $P1//R1 < 5 K\Omega$
 - 2) $\frac{P1_{max}}{R1} = 4 \text{ to } 5$

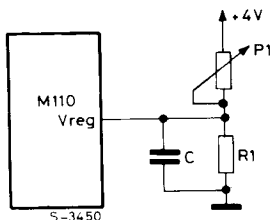

The values suggested for the four capacitances are respectively:

$$4^{\circ}C = 0.107 \mu F; 9^{\circ}C = 0.214 \mu F; 16^{\circ}C = 0.429 \mu F; 32^{\circ}C = 0.858 \mu F.$$

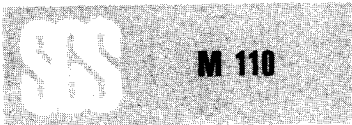

Outputs with simultaneous sawtooth on footages 4', 8', 16', 32'

- The sawtooth can also be obtained simultaneously on 4 different footages: the diagram to be used is shown below.
- The zeroing pulses for 4', 8', 16' pulses are obtained by means of the rising fronts of the relative square wave outputs; for 32' however the 20 μs pulse is used, with the command for selection of the sawtooth on 32'.

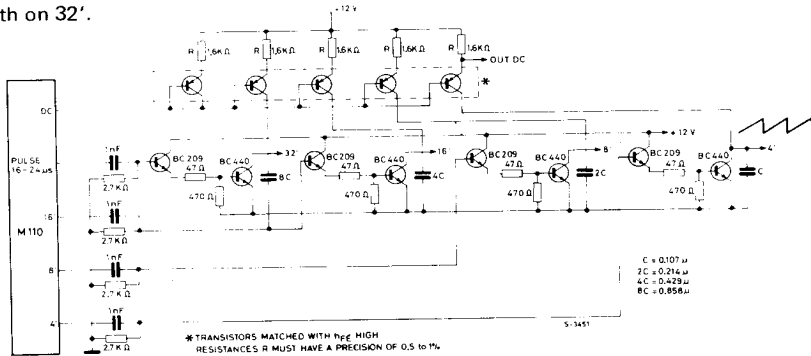

USE OF THE M108 AND M110 SIMULTANEOUSLY WITH ONLY ONE CONTACT FOR KEY

Application

The M108 and the M110 have the same connection with the keyboard therefore only one contact per key is sufficient to drive both the devices: one is the master, with outputs F1 to F12 connected to the keyboard switches, the other is the slave and will receive the information in bus B1 to B6 together with the master.

The synchronization is made by the reset (sync.) pin.

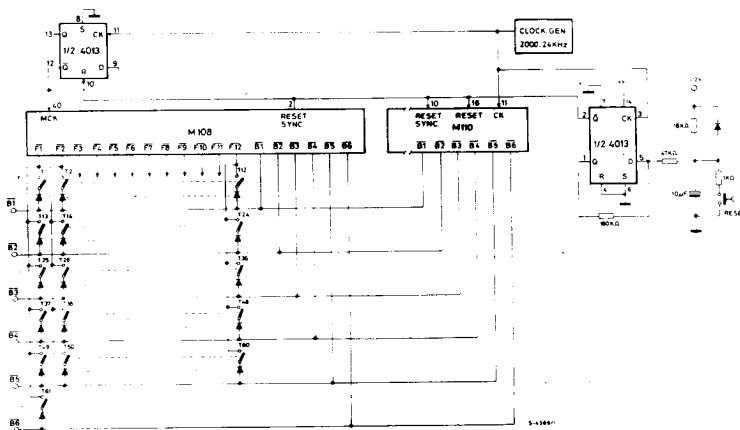

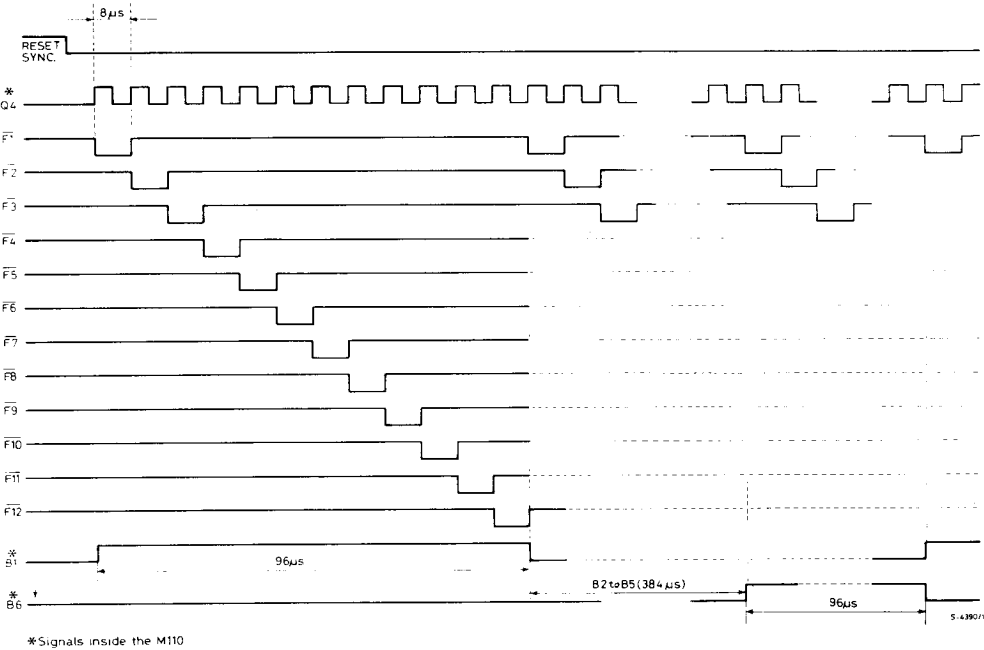
TIMING DIAGRAMS (KEYBOARD SCANNING)

INPUT CLOCK WAVEFORM (pin 11)
