

18 W BTL AUDIO POWER AMPLIFIER

MB3731

September 1988
Edition 1.0

18 W BTL AUDIO POWER AMPLIFIER

The Fujitsu MB3731 is designed for a low-frequency high-power amplifier with internal BTL (Balanced Transformer Less) circuitry. The MB3731 is packed in 12 pin Single in line plastic package and requires a few external components, this enables high density mounting. Design for heat radiation is easy because thermal resistance is low.

The MB3731 contains internal power-on pop noise protection circuit and various protection circuitry. The device is suitable best for car-stereo.

- High power output : 18W typ.
- Minimum external components
- On-chip power on pop noise protection circuit
- Audio mute function is provided
- Separated GND pins for Input/Output circuit
- Various protection circuits
 - Over voltage protection
 - Load short protection
 - Thermal protection
 - Output pin-to-DC short protection
- 12-lead Plastic single in-line Package (Suffix: -PS)

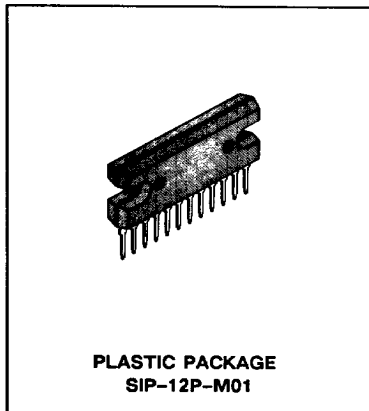

3

ABSOLUTE MAXIMUM RATINGS (see NOTE) (T_C=25°C)

Rating	Symbol	Value	Unit
Power Supply Voltage	V _{CC}	18	V
Power Supply Voltage (Surge)	V _{CCS}	40 *	V
Output Current (Peak)	I _{OPEAK}	4.5	A
Power Dissipation	P _D	18	W
Operating Temperature (Case)	T _C	-20 to +75	°C
Storage Temperature	T _{STG}	-55 to +150	°C

Note:

* t_s ≤ 0.2 sec, t_r ≥ 1 msec
Permanent device damage may occur if the above Absolute Maximum Ratings are exceeded. Functional operation should be restricted to the conditions as detailed in the operational sections of this data sheet. Exposure to absolute maximum rating conditions for extended periods may affect device reliability.

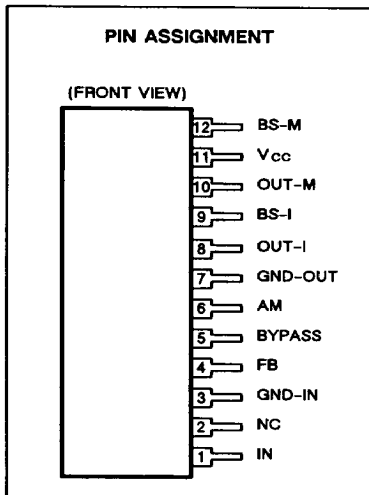

This device contains circuitry to protect the inputs against damage due to high static voltages or electric fields. However, it is advised that normal precautions be taken to avoid application of any voltage higher than maximum rated voltages to this high impedance circuit.

Fig. 1 - MB3731 BLOCK DIAGRAM

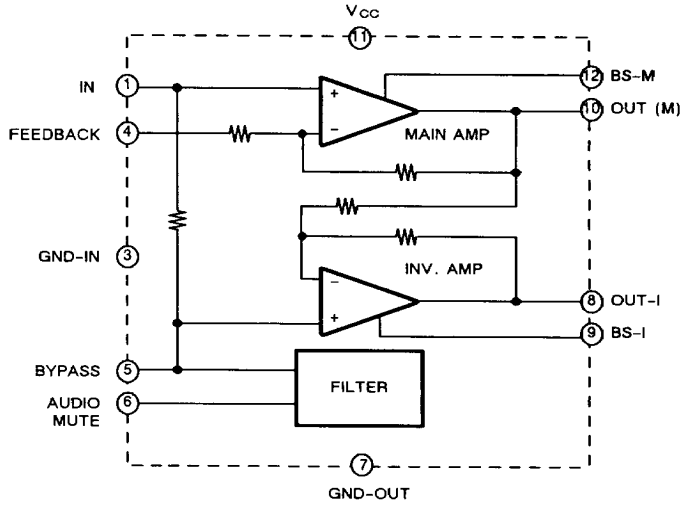

RECOMMENDED OPERATING CONDITIONS

Parameter	Symbol	Value	Unit
Power Supply Voltage	Vcc	8 to 16	V
Operating Temperature (Case)	Tc	-20 to +75	°C

ELECTRICAL CHARACTERISTICS ($T_A = 25^\circ\text{C}$, $V_{CC} = 13.2\text{V}$, $R_L = 4\Omega$, $f = 1\text{kHz}$)

Parameter	Symbol	Condition	Values			Unit
			Min	Typ	Max	
Quiescent Power Supply Current	I_Q	$V_{IN} = 0\text{V}, R_L = \infty$		80	200	mA
Voltage Gain	A_V	$P_0 = 1\text{W}$	44.5	47	49.5	dB
Output Power	P_0	THD=10%	15	18		W
Total Harmonic Distortion	THD	$P_0 = 1\text{W}$		0.1	0.5	%
Output Noise Voltage	V_{NO}	$R_0 = 10\text{k}\Omega, BW = 20\text{HZ to } 20\text{KHZ}$		0.5	1.0	mV
Input Resistance	R_{IN}		40	70		$\text{k}\Omega$
Output Offset Voltage	V_{OO}	$V_{IN} = 0\text{V}$		0.2	0.4	V
Audio Mute Attenuation	—	$P_0 = 1\text{W}$		43		dB

3

Fig. 2 - TYPICAL CONNECTION EXAMPLE

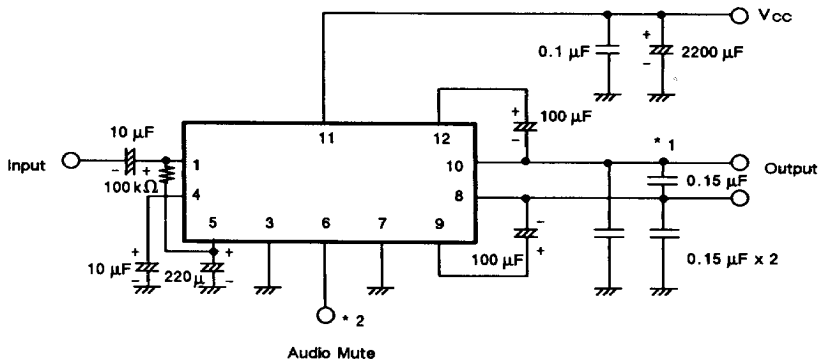

- Notes:
- *1 Effective to prevent from the oscillation depending on printing pattern.
 - *2 The output can be cut off (Audio Mute) when pin 6 is connected with the GND.

Fig. 3 - RECOMMENDED CONNECTION PATTERN (BOTTOM VIEW)

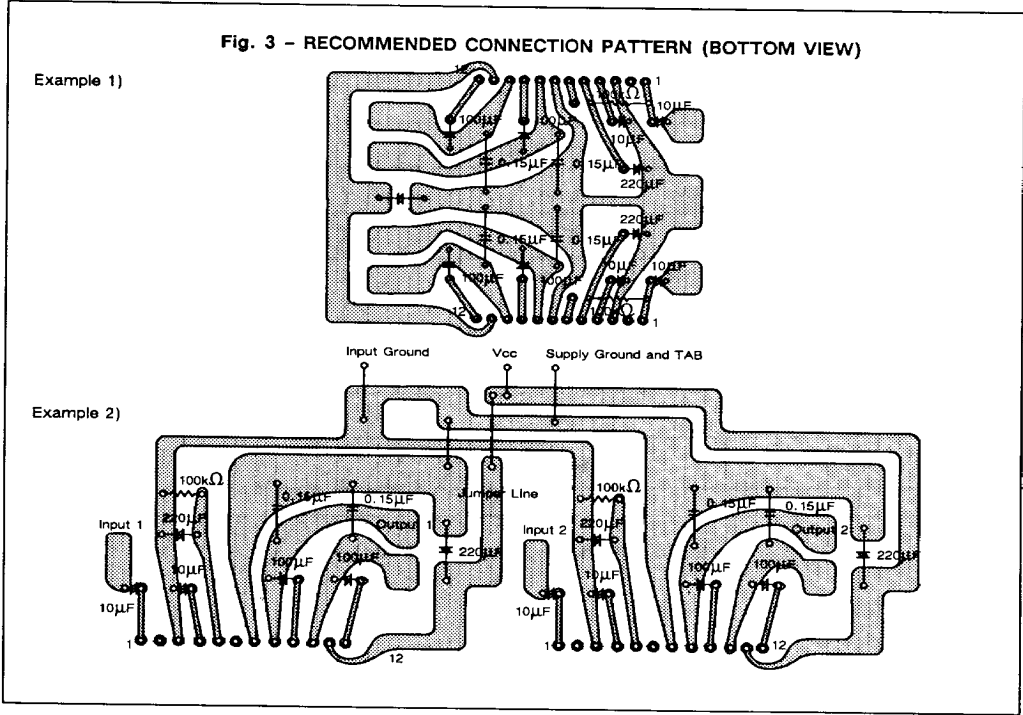

TYPICAL CHARACTERISTICS CURVES

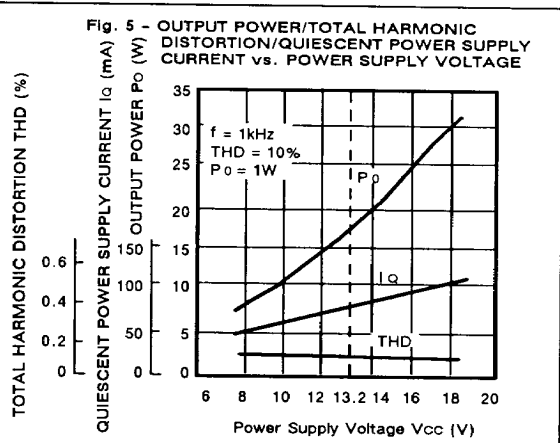
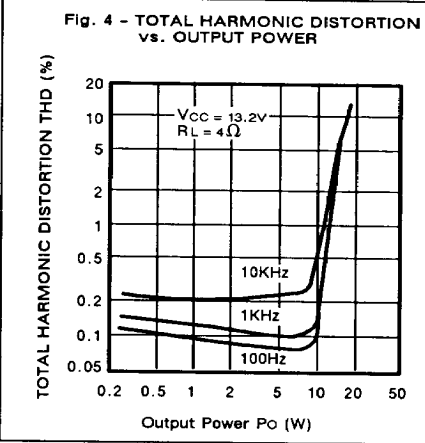

TYPICAL CHARACTERISTICS CURVES (Continued)

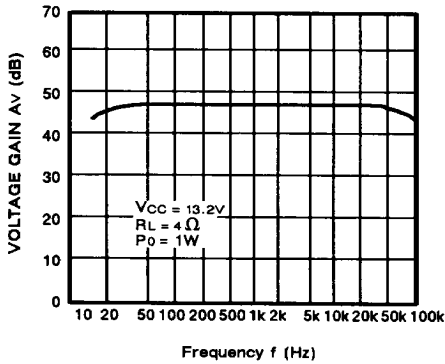
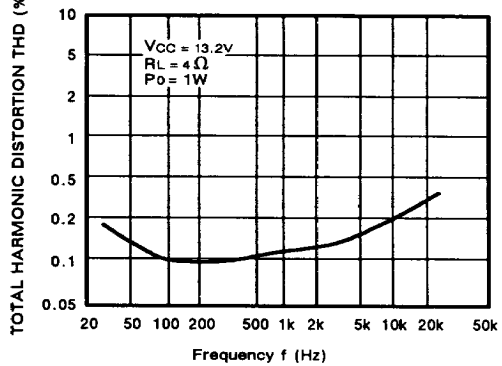
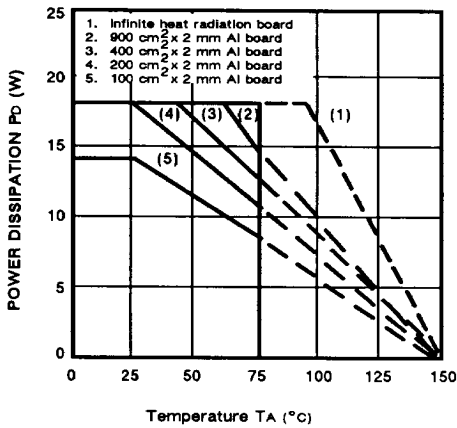
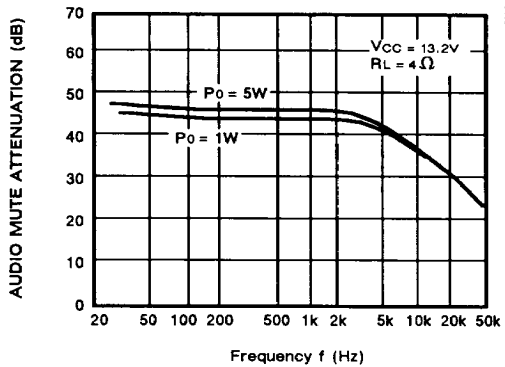
Fig. 6 - VOLTAGE GAIN vs. FREQUENCY

Fig. 7 - TOTAL HARMONIC DISTORTION vs. FREQUENCY

Fig. 8 - POWER DISSIPATION vs. TEMPERATURE

Fig. 9 - AUDIO MUTE ATTENUATION vs. FREQUENCY



MB3731

PACKAGE DIMENSION

3

