

# Signetics

SCN2670  
May 1983

*Mack ROM  
2 Standard Fonts - OK build  
# 5 w/ 17x18  
# 22*

# Display Character & Graphics Generator (DCGG)

85

004124

*orig*

4124

816

Signetics reserves the right to make changes in the products contained in this document in order to improve design or performance and to supply the best possible products. Signetics also assumes no responsibility for the use of any circuits described herein, conveys no license under any patent or other right, and makes no representations that the circuits are free from patent infringement. Applications for any integrated circuits contained in this publication are for illustration purposes only and Signetics makes no representation or warranty that such applications will be suitable for the use specified without further testing or modification. Reproduction of any portion hereof without the prior written consent of Signetics is prohibited.

**DESCRIPTION**

The Signetics Display Character and Graphics Generator (DCGG) is a mask-programmable 11,648-bit line select character generator. It contains 128 10X9 characters placed in a 10X16 matrix, and has the capability of shifting certain characters, such as j, y, g, p and q, that normally extend below the baseline. Character shifting, previously requiring additional external circuitry, is now accomplished internally by the DCGG; effectively, the 9 active lines are lowered within the matrix to compensate for the character's position.

Seven bits of an 8-bit address code are used to select 1 of the 128 available characters. The eighth bit functions as a chip enable signal. Each character is defined by a pattern of logic 1s and 0s stored in a 10X9 matrix. When a specific 4-bit binary line address code is applied, a word of 10 parallel bits appears at the output. The lines can be sequentially selected, providing a 9-word sequence of 10 parallel bits per word for each character selected by the address inputs. As the line address inputs are sequentially addressed, the device will automatically place the 10X9 character in 1 of 2 pre-programmed positions on the 16-line matrix with the positions defined by the 4-line address inputs. One or more of the 10 parallel outputs can be used as control signals to selectively enable functions such as half-dot shift, color selection, etc.

The 2670 DCGG includes latches to store the character address and line address data. A control input to inhibit character data output for certain groups of characters is also provided. The 2670 also includes a graphics capability, wherein the 8-bit character code is translated directly into 256 possible user programmable graphic patterns. Thus, the DCGG can generate data for 384 distinct patterns, of which 128 are defined by the mask programmable ROM. See figure 1 for a typical applications display.

**FEATURES**

- 128 10X9 matrix characters
- 256 graphic characters
- Optional thin graphics for forms
- Character and line address latches
- Internal descend logic
- 200nsec and 300nsec character select access time versions
- Control character output inhibit logic
- Static operation—no clocks required
- Single 5V power supply
- TTL compatible inputs and outputs

**PIN CONFIGURATION**

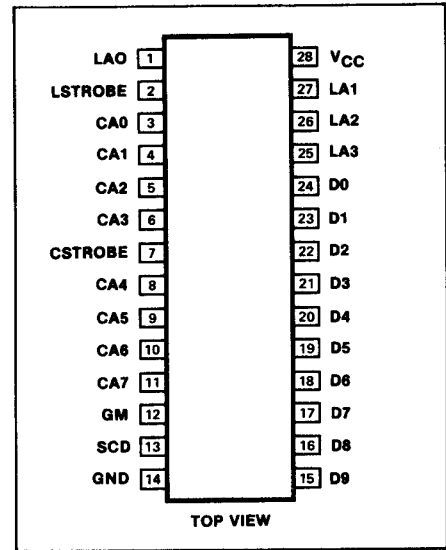

**ORDERING CODE**

PACKAGES	$V_{CC} = 5V \pm 5\%$ , $T_A = 0^\circ C$ to $70^\circ C$	
	$t_{CA} = 200ns$	$t_{CA} = 300ns$
Ceramic DIP	SCN2670*G2I28	SCN2670*C3I28
Plastic DIP	SCN2670*C2N28	SCN2670*C3N28

NOTE  
Substitute letter corresponding to standard font for '\*' in part number for standard parts. See back of data sheet. Contact sales office for custom ROM patterns.

**BLOCK DIAGRAM**

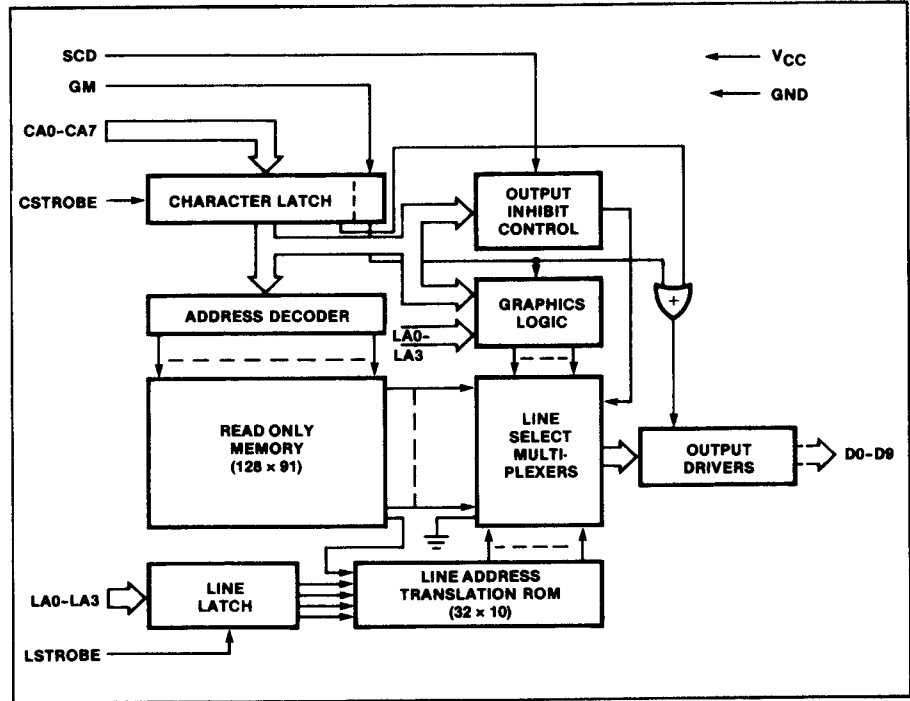

PIN DESIGNATION

MNEMONIC	PIN NO.	TYPE	NAME AND FUNCTION
CA0-CA7	3-6, 8-11	I	<b>Character Address:</b> Eight bit code specifies the character or graphic pattern for which matrix data is to be supplied. In character mode (GM=0), CA0 thru CA6 select one of the 128 ROM-defined characters and CA7 is a chip enable. The outputs are active when CA7=1 and are tri-stated when CA7=0. In graphics mode (GM=1), the outputs are active and CA0 thru CA7 select one of 256 possible graphic patterns to be output.
CSTROBE	7	I	<b>Character Strobe:</b> Used to store the character address (CA0 thru CA7) and graphics mode (GM) inputs into the character latch. Data is latched on the negative going edge of CSTROBE.
GM	12	I	<b>Graphics Mode:</b> GM=0 (low) selects character mode; GM= 1 (high) selects graphics mode.
LA0-LA3	1, 25-27	I	<b>Line Address:</b> In character mode, selects one of the 16 lines of matrix data for the selected character to appear at the 10 outputs. LA0 is the LSB and LA3 is the MSB. The input codes which cause each of the nine lines of character data to be output are specified as part of the programming data for both non-shifted and shifted fonts. Cycling through the nine specified counts at the LA0 thru LA3 inputs cause successive lines of data to be output on D0 thru D9. The 7 non-specified codes for both non-shifted and shifted characters cause blanks (logic zeros) to be output. In graphics mode, the line address gates the latched graphics data directly to the outputs.
LSTROBE	2	I	<b>Line Strobe:</b> Used to store the line address data (LA0 thru LA3) in the line address latch. Data is latched on the negative going edge of LSTROBE.
SCD	13	I	<b>Selected Character Disable:</b> In character mode, a high level at this input causes all outputs (regardless of line address) to be blanks (zeros) for characters for which CA6 and CA5 are both 0. A low level input selects normal operation. Inoperative in the graphics mode.
D9-D0	15-24	O	<b>Data Outputs:</b> Provide the data for the specified character and line.
VCC	28	I	+5V power supply.
GND	14	I	Ground.

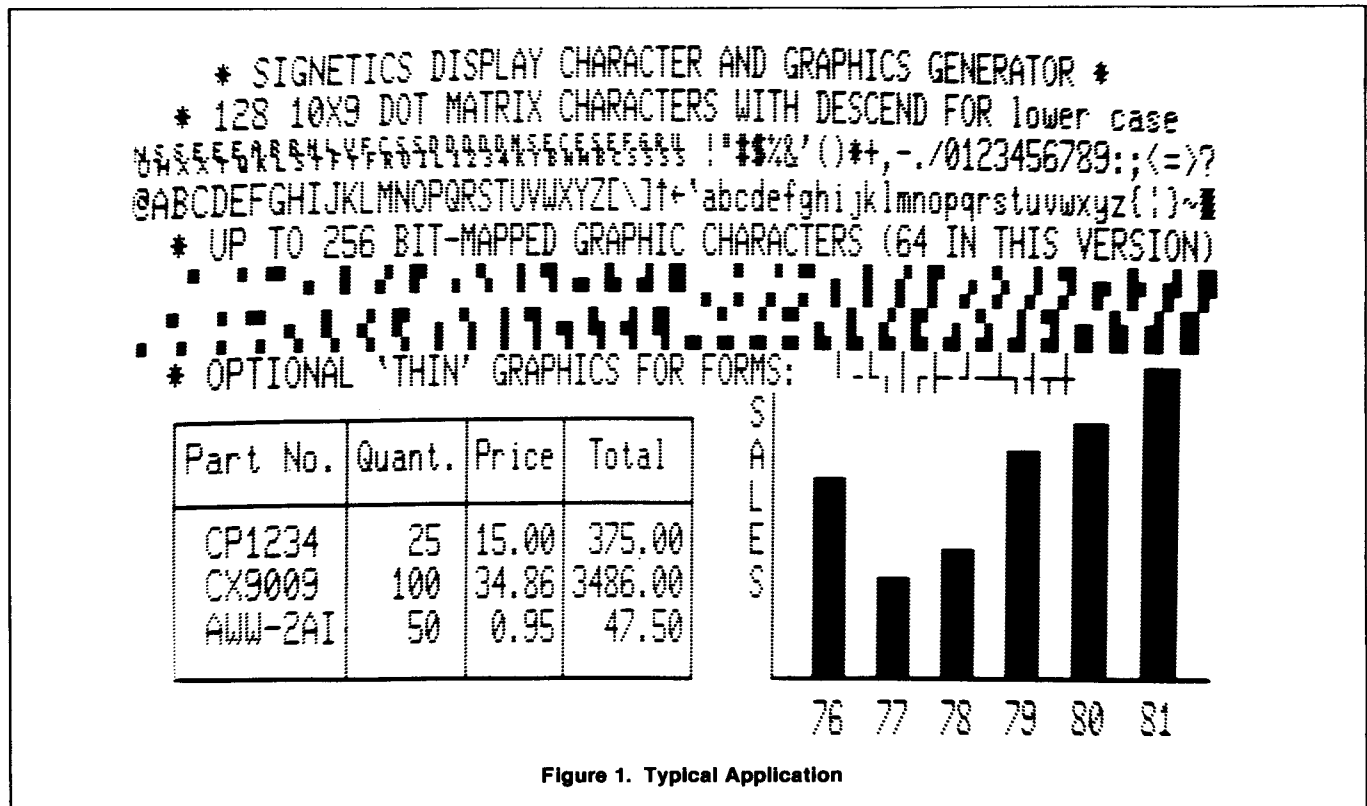

Figure 1. Typical Application

**FUNCTIONAL DESCRIPTION**

The DCGG consists of nine major sections. Line and character codes are strobed into the line and character latches. The character latch outputs are presented to the three sources of data; the ROM through an address decoder, the graphics logic, and the output inhibit control. The output inhibit control (together with the SCD input) suppresses the ROM data for selected character codes. The outputs from the line latch drive the line address translation ROM which maps the character ROM data onto 9 of 16 line positions. Finally, the line select multiplexers route the ROM or graphics data to the output drivers on D0 through D9.

**Character Latch**

The character latch is a 9-bit edge triggered latch used to store the character address (CA0 thru CA7) and graphics mode (GM) inputs. The data is stored on the falling edge of CSTROBE. Seven latched addresses (CA0 thru CA6) are inputs to the ROM character address decoder. In character mode (GM=0), CA7 operates as a chip enable. The output drivers are enabled when CA7=1 and are tri-stated when CA7=0. In graphics mode (GM=1), the output drivers are always enabled and the CA0 thru CA7 outputs of the latch are used to generate graphic symbols.

**Character Address Decoder**

This circuit decodes the 7-bit character address from the character latch to select one

of the 128 character fonts stored in the ROM section of the DCGG.

**Read Only Memory**

The 11,648-bit ROM stores the fonts for the 128 matrix-defined characters. The data for each character consists of 91 bits. Ninety bits represent the 10X9 matrix and one bit specifies whether the character data is output at the normal (unshifted) lines or at the descended (shifted) lines. The 90 data bit outputs are supplied to the line select multiplexers. The descend control bit is an input to the line address translation ROM.

**Graphics Logic**

When the GM input is zero (low), the DCGG operates in the character mode. When it is one (high), it operates in the graphics mode. In graphics mode, output data is generated by the graphics logic instead of the ROM. The graphics logic maps the latched character address (CA0 thru CA7) to the outputs (D0 thru D9) as a function of line address (LA0 thru LA3). For any particular line address value, two of the CA bits are output: CA0, CA2, CA4 or CA6 is output on D0 thru D4 and CA1, CA3, CA5 or CA7 is output on D5 thru D9. The outputs are paired: When CA0 is output on D0 thru D4, CA1 is output on D5 thru D9 and likewise for CA2-CA3, CA4-CA5 and CA6-CA7.

A ROM within the graphics logic allows the specific line numbers for which each pair of bits is output to be specified by the customer. Figure 2 illustrates the general format for

graphics symbols and an example where (CA7 thru CA0) = H'65'. The outputs from the graphics logic go to the line select multiplexers. The multiplexers route the graphic symbol data to the outputs when GM = 1.

**Thin Graphics Option**

As a customer specified option, 16 of the possible graphic codes (H'80' to H'8F') may be used to generate the special graphic characters illustrated in figure 3. For each of these characters, the vertical component appears on the D4 output. The horizontal component occurs on L<sub>H</sub> which is specified by the customer. The vertical components specified by CA0 and CA2 are output for line addresses zero thru L<sub>H</sub> and L<sub>H</sub> thru fifteen, respectively.

**Line Select Multiplexers**

The ten line select multiplexers select ROM data as specified by the line address translation ROM when GM=0, or graphics data when GM=1. The inputs to each multiplexer are the nine line outputs from the ROM, an output from the graphics logic and a logic zero (ground).

**Output Drivers**

Ten output drivers with 3-state capability serve as buffers between the line select multiplexers and external logic. The 3-state control input to these drivers is supplied from the CA7 latch when GM=0. When GM=1, the outputs are always active.

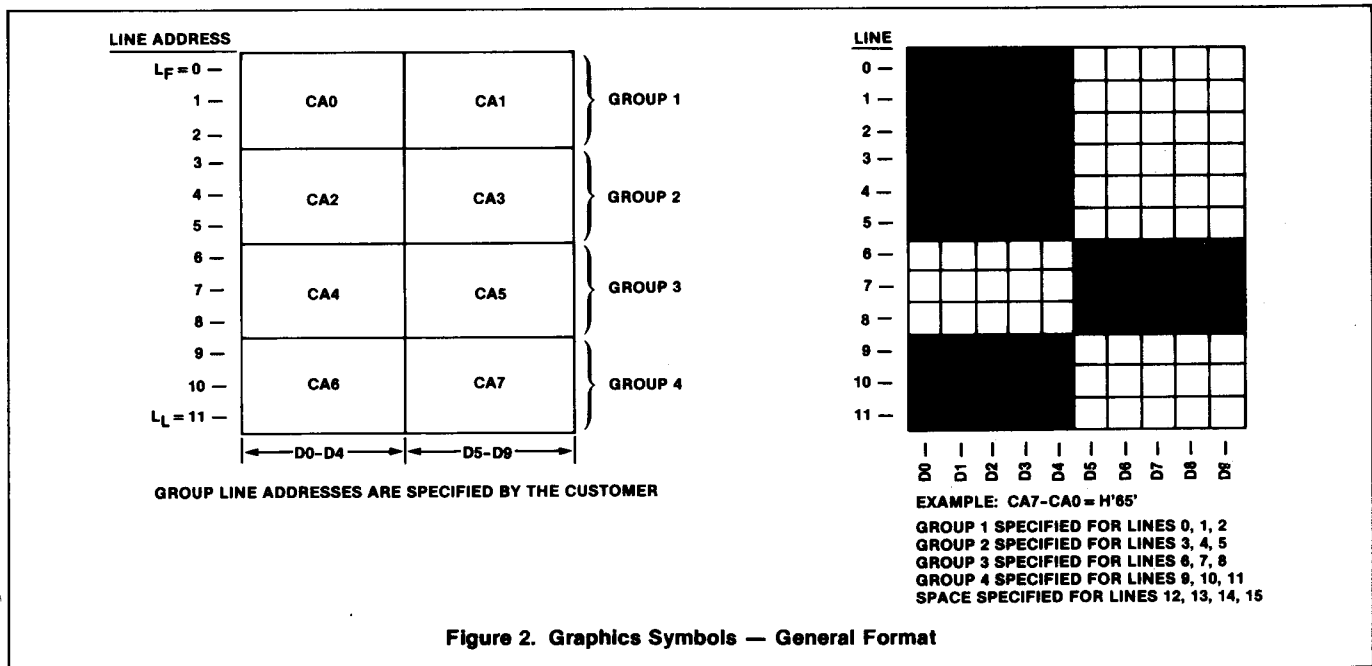

Figure 2. Graphics Symbols — General Format



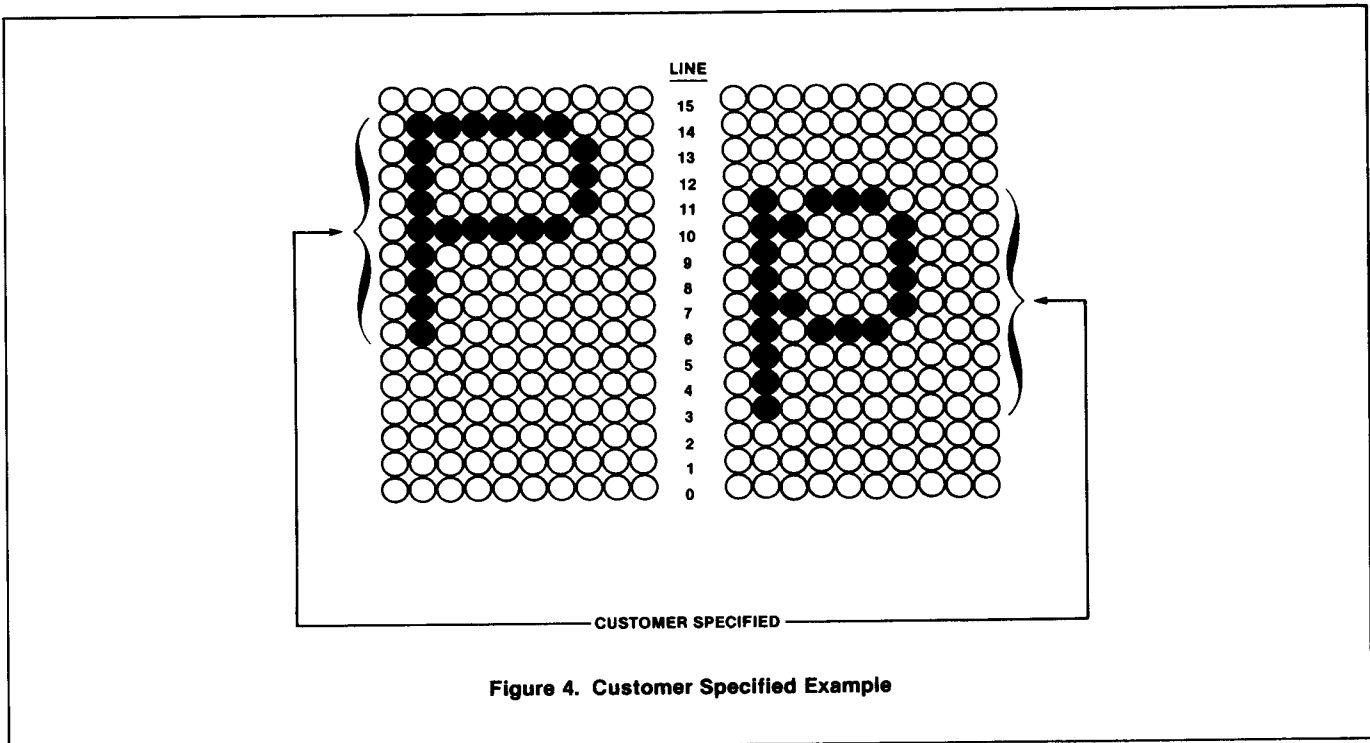

Figure 4. Customer Specified Example

On receipt of a card deck, Signetics will translate the card deck to a truth table using the Signetics Computer Aided Design (CAD) facility. The truth table and font diagrams will then be sent to the customer for final approval. On receipt of final approval, Signetics will produce masks and proceed with manufacturing.

Programming information can also be input on TTY 7-level tape as card images. Each card image must be terminated with a carriage return-line feed. An EOT character must signify the end of the data set.

Customer identification cards are always labeled with a C in column 1. For customer identification, four cards are required. Any number of additional customer identification cards are permitted. The following data should be included:

**CUSTOMER ID CARD # 1**

COLUMN	DATA
1	C
2	blank
3-9	2670/CP
10-14	blank
15-70	Company name/ company part number
71-80	blank

**CUSTOMER ID CARD # 2**

COLUMN	DATA
1	C
2	blank
3-70	Customer contact person name / phone number
71-80	blank

**CUSTOMER ID CARD #5 THRU N**

COLUMN	DATA
1	C
2	blank
3-70	Any information desired
71-80	blank

**CUSTOMER ID CARD # 3**

COLUMN	DATA
1	C
2	blank
3-70	Customer address
71-80	blank

**CUSTOMER ID CARD # 4**

COLUMN	DATA
1	C
2	blank
3-70	Customer city, state, zip code
71-80	blank

The following masking information cards must be included:

**Mask Information Card #1:  
Shift and Nonshift Character Translation Data**

COLUMN	DATA
1-9	NONSHIFT=
10	Line address in hex which outputs the first font word for nonshifted ROM fonts
11	,
12	Line address in hex which outputs the second font word for nonshifted ROM fonts
13	,
14	third
15	,
16	fourth
17	,
18	fifth
19	,
20	sixth
21	,
22	seventh
23	,
24	eighth
25	,
26	ninth
27-29	blank
30-35	SHIFT=
36	Line address in hex which outputs the first font word for shifted ROM fonts
37	,
38	second
39	,
40	third
41	,
42	fourth
43	,
44	fifth
45	,
46	sixth
47	,
48	seventh
49	,
50	eighth
51	,
52	ninth
53-59	blank
60 <sup>1</sup>	0 or 1
61-64	blank
65 <sup>2</sup>	0 or 1
66-80	blank

**NOTES**

- Column 60 specifies the font truth table horizontal format. 0 specifies left to right printing of D0 thru D9. 1 specifies D9 thru D0.
- Column 65 specifies the font truth table vertical printout format. 0 specifies top to bottom printing of line address hex 0 thru F. 1 specifies hex F thru 0.

**MASK INFORMATION CARD #2:  
Graphics Translation Data**

COLUMN	DATA
1-14	THIN GRAPHICS=
15-17	YES or NO $\emptyset$ , where $\emptyset$ = blank. Specifies whether graphics address hex 80 thru hex 8F will select the special thin graphics font.
18-19	blank
20-23	HOR=
24	The line address in hex for the horizontal segments of line graphics fonts. Leave blank if columns 15 thru 17 are NO
25-29	blank
30-45	Graphics group number 1 or 2 or 3 or 4 or blank. Columns 30 thru 45 correspond to line address hex 0 thru hex F respectively. The group number specified in each column will cause the graphics data generated by that group to be output at the corresponding line address. A blank specifies no data for that address.
46-80	blank

**MASK INFORMATION CARD #3 THRU #130:  
ROM Font Data**

COLUMN	DATA
1-2	Character address in hex (CA6 thru CA0)*
3	blank
4	S for shifted; N for nonshifted.
5	blank
6-8	Data for first ROM font word in hex (D9 thru D0).
9	blank
10-12	second
13	blank
14-16	third
17	blank
18-20	fourth
21	blank
22-24	fifth
25	blank
26-28	sixth
29	blank
30-32	seventh
33	blank
34-36	eighth
37	blank
38-40	ninth
41-80	blank

**NOTE**

\*A separate card is required for each character address hex 00 thru hex 7F.



**Printouts**

Signetics will translate the card deck to the following printouts to be submitted to the customer for approval:

- A repeat of all customer information.
- A separate font drawing for each of the 128 ROM characters and 256 graphics fonts. The font drawings are positioned on a 10 X 16 matrix as specified by the customer's translation data.

**SAMPLE CARD DECK INPUT**

```

SIGNETICS C 2670/CP1000PA 2670 TEST RUN 04/16/79
THIN GRAPHICS=YES HOR=7 1112223334444
NONSHIFT=1,2,3,4,5,6,7,8,9 SHIFT=3,4,5,6,7,8,9,A,B 0 0
00 N 022 026 02A n32 0AA 088 088 088 070 40 N 078 084 082 nCA 08A 072 002 084 078
01 N 01C 002 00C n10 08E 088 0F8 088 088 41 N 010 028 044 n82 082 0FE 082 082 082
02 N 01C 002 00C n10 08E 050 020 050 088 42 N 03E 044 084 n44 03C 044 084 044 03E
03 N 01E 002 00E 002 09E 050 020 050 088 43 N 078 084 002 n02 002 002 002 084 078
04 N 01E 002 00E n02 01E 0F8 020 020 020 44 N 03E 044 084 n84 084 084 084 044 03E
05 N 01E 002 00E n02 06E 090 090 0D0 0E0 45 N 0FE 002 002 n02 03E 002 002 002 0FE
06 N 00C 012 01E n12 092 050 030 050 090 46 N 0FE 002 002 n02 03E 002 002 002 002
07 N 00E 012 00E n12 00E 010 010 010 0F0 47 N 078 084 002 n02 002 0E2 082 0C4 088
08 N 00E 012 00E 012 0EE 010 060 080 070 48 N 082 082 082 n82 0FE 082 082 082 082
09 N 012 012 01E n12 012 0F8 020 02C 020 49 N 07C 010 010 n10 010 010 010 010 07C
0A N 002 002 002 n1E 0F0 010 070 010 010 4A N 0E0 040 040 n40 040 040 042 042 03C
0B N 022 022 022 n14 008 0F8 020 020 020 4B N 082 042 022 n12 00A 016 022 042 082
0C N 01E 002 00E n02 0F2 010 070 010 010 4C N 002 002 002 n02 002 002 002 002 07E
0D N 01C 002 002 n02 07C 090 070 050 090 4D N 082 0C6 0AA n92 092 082 082 082 082
0E N 01C 002 00C n10 06E 090 090 090 060 4E N 082 082 086 n8A 092 0A2 0C2 082 082
0F N 01C 002 00C n10 0EE 040 040 040 0E0 4F N 038 044 082 n82 082 082 082 044 038
10 N 00E 012 012 n12 00E 010 010 010 0F0 50 N 07E 082 082 n82 07E 002 002 002 002
11 N 00E 012 012 n12 04E 060 040 040 0E0 51 N 038 044 082 n82 082 092 0A2 044 088
12 N 00E 012 012 n12 06E 090 040 020 0F0 52 N 07E 082 082 n82 07E 012 022 042 082
13 N 00E 012 012 n12 06E 080 060 080 070 53 N 078 084 002 n04 038 040 080 042 03C
14 N 00E 012 012 n12 04E 060 050 0F8 040 54 N 0FE 010 010 n10 010 010 010 010 010
15 N 012 016 01A n12 092 050 030 050 090 55 N 082 082 082 n82 082 082 082 044 038
16 N 01C 002 00C n10 08E 050 020 020 020 56 N 082 082 082 n44 044 028 028 010 010
17 N 01E 002 00E n02 07E 090 070 090 070 57 N 082 082 082 n82 082 092 092 0AA 044
18 N 01C 002 002 n02 01C 090 090 0D0 090 58 N 082 082 044 n28 010 028 044 082 082
19 N 01E 002 00E n02 01E 088 0D8 0A8 088 59 N 082 082 044 n28 010 010 010 010 010
1A N 01C 002 00C n10 07E 090 070 090 070 5A N 0FE 080 040 n20 010 008 044 002 0FE
1B N 01E 002 00E n02 01E 0E0 010 010 0E0 5B N 07C 004 004 n04 004 004 004 004 07C
1C N 01E 002 00E n02 0E2 010 060 080 070 5C N 000 002 004 n08 010 020 040 080 000
1D N 01C 002 01A n12 0EC 010 060 080 070 5D N 07C 040 040 n40 040 040 040 040 07C
1E N 00E 012 00E n0A 0F2 010 060 080 070 5E N 010 038 054 n10 010 010 010 010 010
1F N 012 012 012 n12 0EC 010 060 080 070 5F N 000 000 008 n04 0FE 004 008 000 000
20 N 000 000 000 n00 000 000 000 000 000 60 N 018 018 010 020 000 000 000 000 000
21 N 010 010 010 n10 010 000 000 010 010 61 N 000 000 000 n3C 040 07C 042 042 08C
22 N 028 028 028 n28 000 000 000 000 000 62 N 002 002 002 n3A 046 042 042 046 03A
23 N 028 028 0FE n28 028 028 0FE 028 028 63 N 000 000 000 n3C 042 002 002 042 03C
24 N 028 0FC 02A n2A 07C 0A8 0A8 07E 028 64 N 040 040 040 n5C 062 042 042 062 05C
25 N 004 08A 044 n20 010 008 044 0A2 040 65 N 000 000 000 n3C 042 07E 002 002 03C
26 N 00C 012 012 n0C 00C 012 0A2 042 08C 66 N 030 048 008 n08 03E 008 008 008 008
27 N 018 018 008 n04 000 000 000 000 000 67 S 000 05C 062 n42 062 05C 040 042 03C
28 N 020 010 008 n08 008 008 008 008 020 020 68 N 002 002 002 n3A 046 042 042 042 042
29 N 008 010 020 n20 020 020 020 010 038 69 N 000 010 000 n18 010 010 010 010 038
2A N 000 010 054 n38 0FE 038 054 010 000 6A S 000 060 040 n40 040 040 040 044 038
2B N 000 010 010 n10 0FE 010 010 010 000 6B N 002 002 002 n22 012 00A 016 022 042
2C S 000 000 000 n00 000 018 018 008 004 6C N 018 010 010 n10 010 010 010 010 038
2D N 000 000 000 n00 00E 000 000 000 000 6D N 000 000 000 n6A 096 092 092 092 092
2E N 000 000 000 n00 000 000 000 018 018 6E N 000 000 000 n3A 046 042 042 042 042
2F N 000 080 040 n20 010 008 004 002 000 6F N 000 000 000 n3C 042 042 042 042 03C
30 N 038 044 0C2 nA2 092 08A 086 044 038 70 S 000 03A 046 n42 046 03A 002 002 002
31 N 010 018 014 n10 010 010 010 010 07C 71 S 000 05C 062 n42 062 05C 040 040 040
32 N 07C 082 080 n40 038 004 002 002 0FE 72 N 000 000 000 n3A 046 002 002 002 002
33 N 07C 082 080 n80 070 080 080 082 07C 73 N 000 000 000 n3C 042 00C 030 042 03C
34 N 040 060 050 n48 044 0FE 040 040 040 74 N 000 008 008 n1C 008 008 008 048 030
35 N 0FE 002 002 n02 07E 080 080 082 07C 75 N 000 000 000 n42 042 042 042 062 05C
36 N 078 084 002 n02 07A 086 082 082 07C 76 N 000 000 000 n44 044 044 044 028 010
37 N 0FE 080 080 n40 020 010 008 004 002 77 N 000 000 000 082 082 092 092 092 06C
38 N 07C 082 082 n44 038 044 082 082 07C 78 N 000 000 000 n42 024 018 018 024 042
39 N 07C 082 082 nC2 08C 080 080 042 03C 79 S 000 042 042 n42 062 05C 040 042 03C
3A N 000 000 000 n18 018 000 000 018 018 7A N 000 000 000 n7E 020 010 008 004 07E
3B S 000 018 018 n00 000 018 018 008 004 7B N 030 008 008 n08 004 008 008 008 030
3C N 020 010 008 n04 002 004 008 010 020 7C N 010 010 010 000 000 010 010 010
3D N 000 000 000 nFE 000 000 0FE 000 000 7D N 018 020 020 n20 040 020 020 020 018
3E N 008 010 020 n40 080 040 020 010 008 7E N 000 000 000 n0C 092 060 000 000 000
3F N 07C 082 082 n80 060 010 010 000 010 7F N 0AA 054 0AA n54 0AA 054 0AA 054 0AA
    
```

ABSOLUTE MAXIMUM RATINGS<sup>1</sup>

PARAMETER	RATING	UNIT
Supply voltage	6.0	V
Operating ambient temperature <sup>2</sup>	0 to +70	°C
Storage temperature	-65 to +150	°C
All voltages with respect to ground <sup>3</sup>	-0.3 to +6.0	V

## NOTES

- Stresses above those listed under Absolute Maximum Ratings may cause permanent damage to the device. This is a stress rating only and functional operation of the device at these or any other condition above those indicated in the operation section of this specification is not implied.
- For operating at elevated temperatures, the device must be derated based on +150°C maximum junction temperature and thermal resistance of 60°C/W junction to ambient (ceramic package).
- This product includes circuitry specifically designed for the protection of its internal devices from the damaging effects of excessive static charge. Nonetheless it is suggested that conventional precautions be taken to avoid applying any voltages larger than the maxima.

DC ELECTRICAL CHARACTERISTICS  $T_A = 0^\circ\text{C}$  to  $70^\circ\text{C}$ ,  $V_{CC} = 5.0\text{V} \pm 5\%$  <sup>1,2,3</sup>

PARAMETER	TEST CONDITIONS	LIMITS			UNIT
		Min	Typ	Max	
$V_{IL}$ Input low voltage		0		0.8	V
$V_{IH}$ Input high voltage		2.0		$V_{CC}$	V
$V_{OL}$ Output low voltage	$I_O = 1.6\text{mA}$	0		0.4	V
$V_{OH}$ Output high voltage	$I_O = -100\mu\text{A}$	2.4		$V_{CC}$	V
$I_{IL}$ Input leakage current	$V_{IN} = 0$ to $4.25\text{V}$			10	$\mu\text{A}$
$I_{OL}$ Output leakage current	$V_O = 0.4$ to $4\text{V}$			$\pm 10$	$\mu\text{A}$
$I_{CC}$ Supply current	$V_{CC} = 5.25\text{V}$		35	80	mA
$C_{IN}$ Input capacitance	All other pins grounded			10	pF
$C_{OUT}$ Output capacitance				15	pF

AC CHARACTERISTICS  $T_A = 0^\circ\text{C}$  to  $+70^\circ\text{C}$ ,  $V_{CC} = 5\text{V} \pm 5\%$  <sup>1,2,3,4</sup>

PARAMETER	LIMITS				Unit
	300ns		200ns		
	Min	Max	Min	Max	
$t_{WS}$ Strobe pulse width	100		100		ns
$t_{LAS}$ Line address setup	50		50		ns
$t_{LAH}$ Line address hold	25		25		ns
$t_{CAS}$ Character address setup	25		15		ns
$t_{CAH}$ Character address hold	25		15		ns
$t_{CA}$ Character select access		300		200	ns
$t_{LA}$ Line select access		500		350	ns
$t_{SEL}$ Chip select delay		250		150	ns
$t_{DES}$ Chip deselect delay		200		125	ns
$t_{SC}$ Special character blank/unblank time		300		200	ns

## NOTES

- Parameters are valid over operating temperature range unless otherwise specified.
- All voltage measurements are referenced to ground. All time measurements are at the 0.8V or 2.0V level for inputs and outputs. Input levels are 0V and 2.4V.
- Typical values are at +25°C, typical supply voltages and typical processing parameters.
- Test conditions:  $C_L = 100\text{pF}$  and 1 TTL load.

TIMING DIAGRAMS

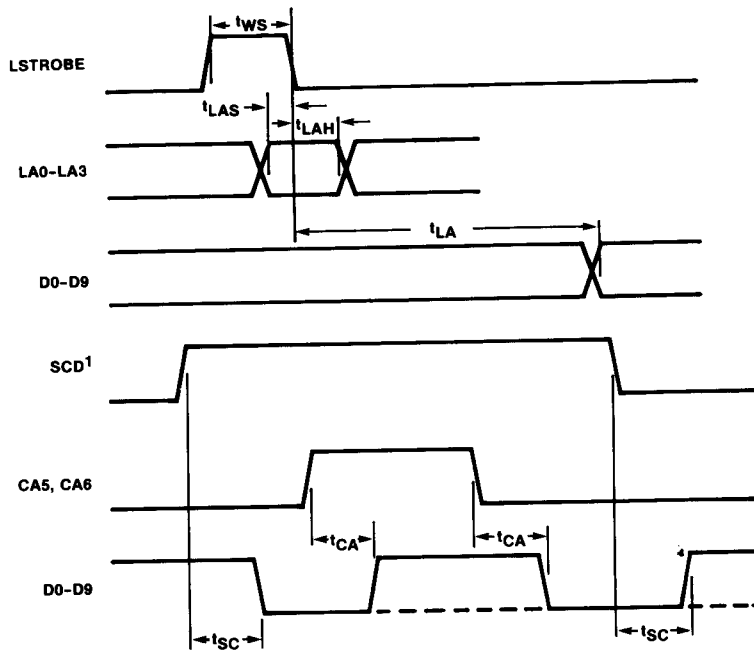

NOTE  
1. WHEN GM = 1, SCD INPUT IS INACTIVE

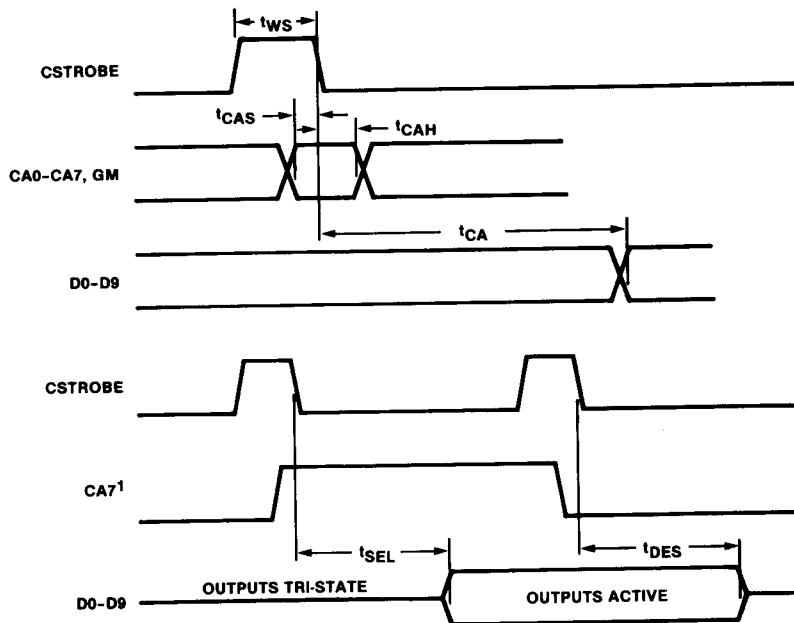

NOTE  
1. CA7 OPERATES AS OUTPUT ENABLE ONLY IN CHARACTER MODE (GM = 0)

# DISPLAY CHARACTER AND GRAPHICS GENERATOR (DCGG)

# SCN2670

PART NO. SCN2670A		1111		1110		1101		1100		1011		1010		1001		1000		0111		0110		0101		0100		0011		0010		0001		0000	
		DO	D9	DO	D9	DO	D9	DO	D9	DO	D9	DO	D9	DO	D9	DO	D9	DO	D9	DO	D9	DO	D9	DO	D9	DO	D9	DO	D9	DO	D9		
CA7 = 1 GM = 0 CA3, CA0 CA8 - CA4	L0	[Character grid for 1111 L0]																															
	L15	[Character grid for 1111 L15]																															
000	L0	[Character grid for 1110 L0]																															
	L15	[Character grid for 1110 L15]																															
001	L0	[Character grid for 1101 L0]																															
	L15	[Character grid for 1101 L15]																															
010	L0	[Character grid for 1100 L0]																															
	L15	[Character grid for 1100 L15]																															
011	L0	[Character grid for 1011 L0]																															
	L15	[Character grid for 1011 L15]																															
100	L0	[Character grid for 1010 L0]																															
	L15	[Character grid for 1010 L15]																															
101	L0	[Character grid for 1001 L0]																															
	L15	[Character grid for 1001 L15]																															
110	L0	[Character grid for 1000 L0]																															
	L15	[Character grid for 1000 L15]																															
111	L0	[Character grid for 0111 L0]																															
	L15	[Character grid for 0111 L15]																															

# DISPLAY CHARACTER AND GRAPHICS GENERATOR (DCGG)

SCN2670

PART NO. SCN2670B		1111		1110		1101		1100		1011		1010		1001		1000		0111		0110		0101		0100		0011		0010		0001		0000			
		DO	DI	DO	DI	DO	DI	DO	DI	DO	DI	DO	DI	DO	DI	DO	DI	DO	DI	DO	DI	DO	DI	DO	DI	DO	DI	DO	DI	DO	DI	DO	DI		
CA7=1	GM=0	L15		L15		L15		L15		L15		L15		L15		L15		L15		L15		L15		L15		L15		L15		L15		L15		L15	
CA3-CA0	CA6-CA4	000	001	010	011	100	101	110	111																										

Signetics