

TOSHIBA MOS MEMORY PRODUCTS

4,096 WORD × 4 BIT STATIC RAM
 SILICON MONOLITHIC
 N-CHANNEL SILICON GATE MOS PROCESS

TMM2068AP-25, TMM2068AP-35
TMM2068AP-45

DESCRIPTION

The TMM2068AP is a 16,384 bits high speed and low power static random access memory organized as 4,096 words by 4 bits and operates from a single 5V supply. Toshiba's high performance device technology provides both high speed and low power features with a maximum access time of 25ns/35ns/45ns and maximum operating current of 135/120/120mA. When \overline{CS} goes high, the device is deselected and placed in a low power standby mode in which maximum standby current is 20mA. Thus the TMM2068AP is most suitable for us in cache memory and high speed storage. The TMM2068AP is offered in a 20 pin standard plastic package with 0.3 inch width for high density assembly. The TMM2068AP is fabricated with ion implanted N channel silicon gate MOS technology for high performance and high reliability.

FEATURES

- Fast access time
 - t_{ACC}=25ns: TMM2068AP-25
 - t_{ACC}=35ns: TMM2068AP-35
 - t_{ACC}=45ns: TMM2068AP-45
- Low power dissipation
 - I_{CC}=135mA: TMM2068AP-25
 - I_{CC}=120mA: TMM2068AP-35
 - I_{CC}=120mA: TMM2068AP-45
 - I_{SB}=20mA
- Single 5V power supply
- Fully static operation
- All inputs and outputs: Directly TTL compatible
- Power down feature : $\overline{CS}=V_{IH}$
- Three state outputs
- Inputs protected: All inputs protection against static charge.
- Package: 20 pins standard plastic package, 0.3 inch width.

PIN CONNECTION

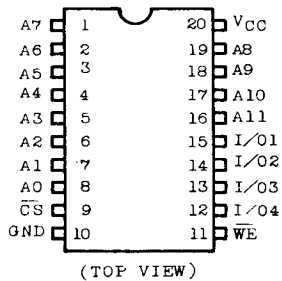

PIN NAMES

A0 ~ A11	Address Inputs
I/O1 ~ I/O4	Data Input/Output
\overline{CS}	Chip Select Input
\overline{WE}	Write Enable Input
V _{CC}	Power (+5V)
GND	Ground

BLOCK DIAGRAM

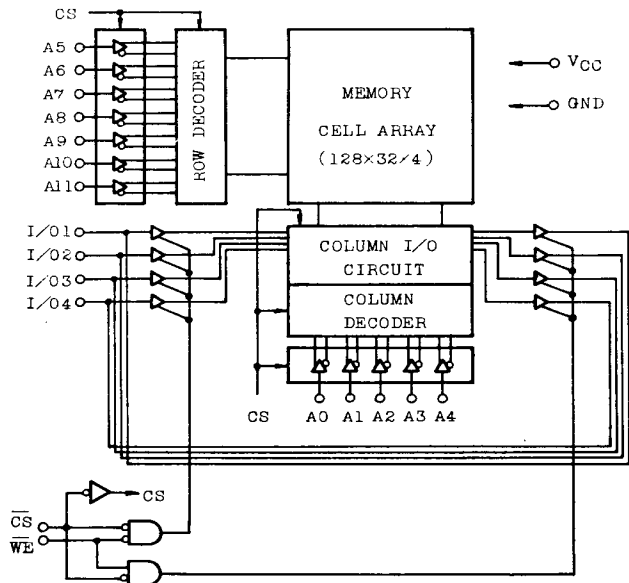

TMM2068AP-25, TMM2068AP-35 TMM2068AP-45

MAXIMUM RATINGS

SYMBOL	ITEM	RATING	UNIT
V _{CC}	Power Supply Voltage	-3.5 ~ 7.0	V
V _{IN}	Input Voltage	-3.5 ~ 7.0	V
V _{I/O}	Input/Output Voltage	-3.5 ~ 7.0	V
T _{opr}	Operating Temperature	0 ~ 70	°C
T _{stg}	Storage Temperature	-55 ~ 150	°C
T _{solder}	Soldering Temperature • Time	260 • 10	°C•sec
P _D	Power Dissipation	1.0	W
I _{OUT}	D.C. Output Current	20	mA

D.C. RECOMMENDED OPERATING CONDITIONS

SYMBOL	PARAMETER	MIN.	TYP.	MAX.	UNIT
V _{IH}	Input High Voltage	2.0	-	V _{CC} +1.0	V
V _{IL}	Input Low Voltage	-3.0*	-	0.8	V
V _{CC}	Power Supply Voltage	4.5	5.0	5.5	V

* Pulse Width: 10ns, DC: -0.5V (Min.)

D.C. CHARACTERISTICS (Ta=0 ~ 70°C, V_{CC}=5V±10%)

SYMBOL	PARAMETER	TEST CONDITION	MIN.	MAX.	UNIT	
I _{IL}	Input Current	V _{IN} =0 ~ V _{CC}	-	±1.0	μA	
V _{OH}	Output High Voltage	I _{OH} =-4.0mA	2.4	-	V	
V _{OL}	Output Low Voltage	I _{OL} =8.0mA	-	0.4	V	
I _{LO}	Output Leakage Current	V _{OUT} =0 ~ V _{CC} , \overline{CS} =V _{IH}	-	±1.0	μA	
I _{CC}	Operating Current	\overline{CS} =V _{IL}	-25	-	135	mA
			-35	-	120	
			-45	-	120	
I _{SB}	Standby Current	\overline{CS} =V _{IH}	-	20	mA	
I _{SBP}	Peak Power-on Current	\overline{CS} =V _{CC} , V _{CC} =0 ~ 5.5V	-	40	mA	

CAPACITANCE* (Ta=25°C, f=1MHz)

SYMBOL	PARAMETER	CONDITIONS	MAX.	UNIT
C _{IN}	Input Capacitance	V _{IN} =0V	8	pF
C _{OUT}	Output Capacitance	V _{OUT} =0V	8	

* Note: This parameter is periodically sampled and is not 100% tested.

TMM2068AP-25, TMM2068AP-35 TMM2068AP-45

A.C. CHARACTERISTICS (Ta=0 ~ 70°C, VCC=5V±10%)

Read Cycle

SYMBOL	PARAMETER	TMM2068AP-25		TMM2068AP-35		TMM2068AP-45		UNIT
		MIN.	MAX.	MIN.	MAX.	MIN.	MAX.	
t _{RC}	Read Cycle Time	25	-	35	-	45	-	ns
t _{ACC}	Address Access Time	-	25	-	35	-	45	
t _{CO}	Chip Select Access Time	-	25	-	35	-	45	
t _{CLZ}	Chip Selection to Output in Low-Z	5	-	5	-	5	-	
t _{CHZ}	Chip Deselection to Output in High-Z	0	15	0	20	-	20	
t _{OH}	Output Data Hold Time	5	-	5	-	5	-	
t _{PU}	Chip Selection to Power Up Time	0	-	0	-	0	-	
t _{PD}	Chip Deselection to Power Down Time	-	20	-	30	-	30	

Write Cycle

SYMBOL	PARAMETER	TMM2068AP-25		TMM2068AP-35		TMM2068AP-45		UNIT
		MIN.	MAX.	MIN.	MAX.	MIN.	MAX.	
t _{WC}	Write Cycle Time	25	-	35	-	45	-	ns
t _{CW}	Chip Selection to End of Write	20	-	30	-	40	-	
t _{AS}	Address Set Up Time	0	-	0	-	0	-	
t _{WP}	Write Pulse Width	20	-	30	-	35	-	
t _{WR}	Write Recovery Time	0	-	0	-	0	-	
t _{WLZ}	WE to Output in Low-Z	0	-	0	-	0	-	
t _{WHZ}	WE to Output in High-Z	0	10	0	15	0	15	
t _{DS}	Data Set Up Time	10	-	15	-	20	-	
t _{DH}	Data Hold Time	0	-	0	-	0	-	

A.C. TEST CONDITIONS

Input Pulse Levels	3.0V/0.0V
Input Rise and Fall Times	5ns
Input and Output Timing Reference Levels	2.0V/0.8V
Output Load	See Fig.1

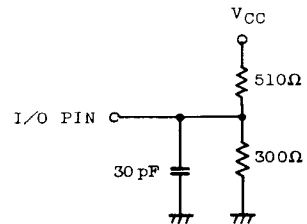
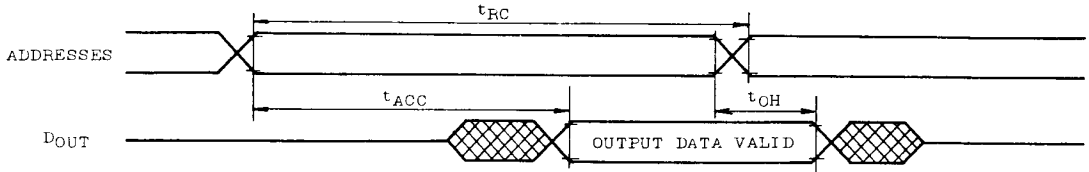

Fig.1 OUTPUT LOAD

TMM2068AP-25, TMM2068AP-35 TMM2068AP-45

TIMING WAVEFORMS

READ CYCLE 1. ($\overline{WE}=V_{IH}$, $\overline{CS}=V_{IL}$)



READ CYCLE 2. ($\overline{WE}=V_{IH}$)

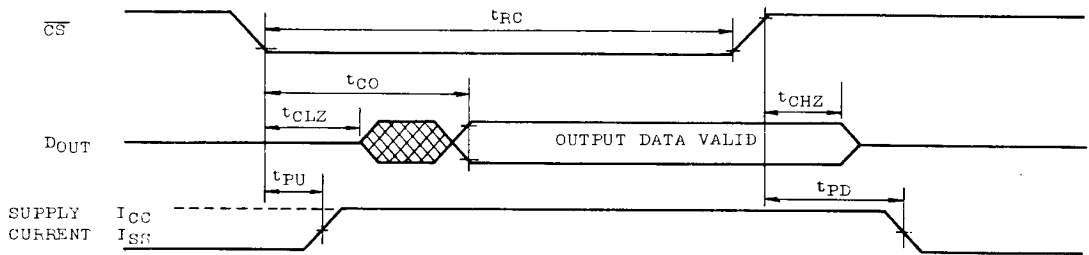

WRITE CYCLE 1.

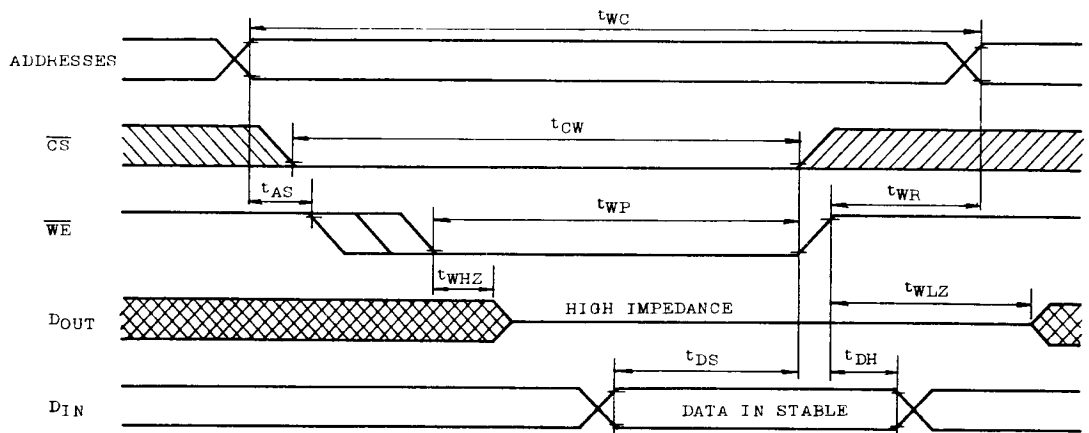

**TMM2068AP-25, TMM2068AP-35
TMM2068AP-45**

WRITE CYCLE 2.

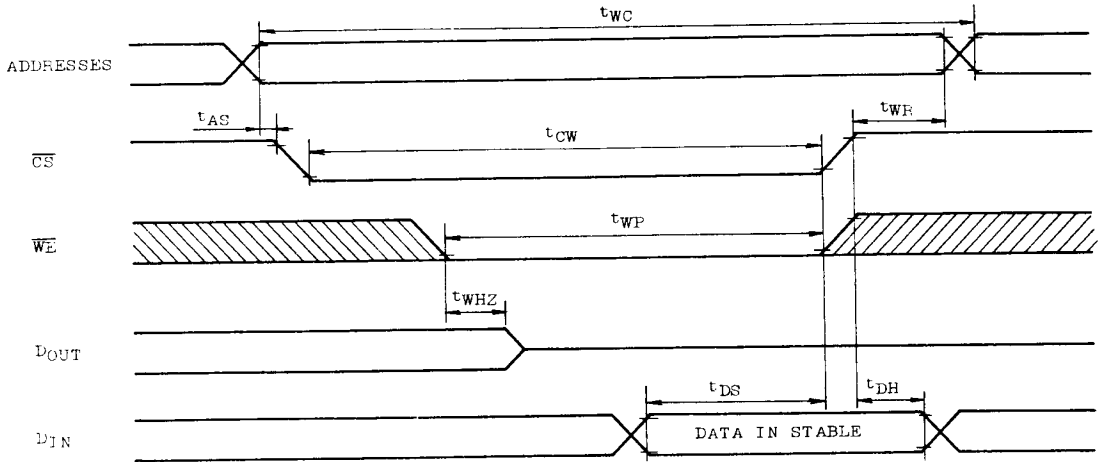

- Note 1. In read cycle 2, all addresses are valid prior to or coincident with \overline{CS} transition low.
2. The operating temperature (T_a) is guaranteed with transverse air flow exceeding 400 linear feet per minute.

TMM2068AP-25, TMM2068AP-35 TMM2068AP-45

OUTLINE DRAWINGS

Unit in mm

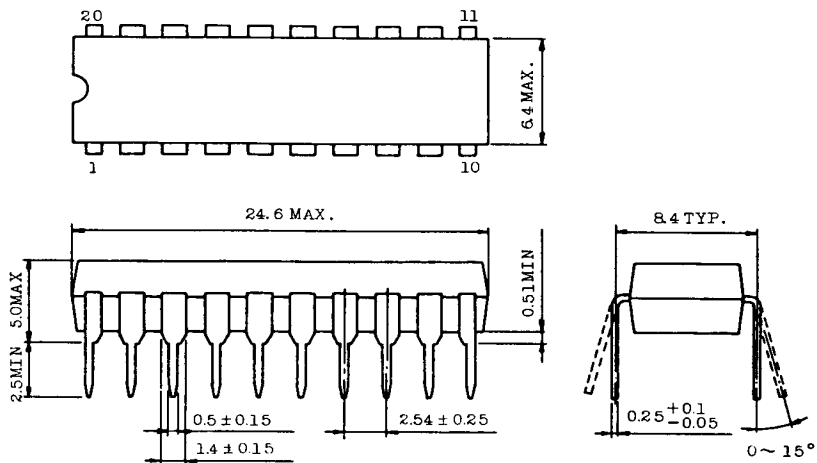

Note: Each lead pitch is 2.54mm.

All leads are located within 0.25mm of their longitudinal position with respect to No.1 and No.20 leads.