

Description

The μ PC1042 is a switching regulator control circuit designed for use in Switch Mode Power Supplies (SMPS). The μ PC1042 uses the Pulse Width Modulator Technique (PWM) and features on chip voltage reference, dual error amplifiers, oscillator, pulse width modulator comparator, pulse steering flip flop, dual phase output drivers, and deadtime adjustment. The μ PC1042 is ideal for forward and push-pull converters with minimum external circuitry.

Features

- Internal oscillator has symmetrical triangular waveform
- Adjustable dead time (0 to 100%)
- Includes a misoperation-preventing circuit at low input voltage
- No double pulsing of outputs
- Error amplifier II can operate with 0 V input voltage level

Pin Configuration

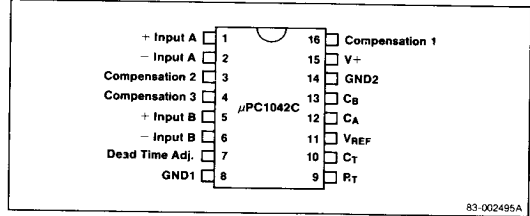

Ordering Information

Part Number	Package	Operating Temperature Range
μ PC1042C	Plastic DIP	-20°C to +85°C

Equivalent Circuit

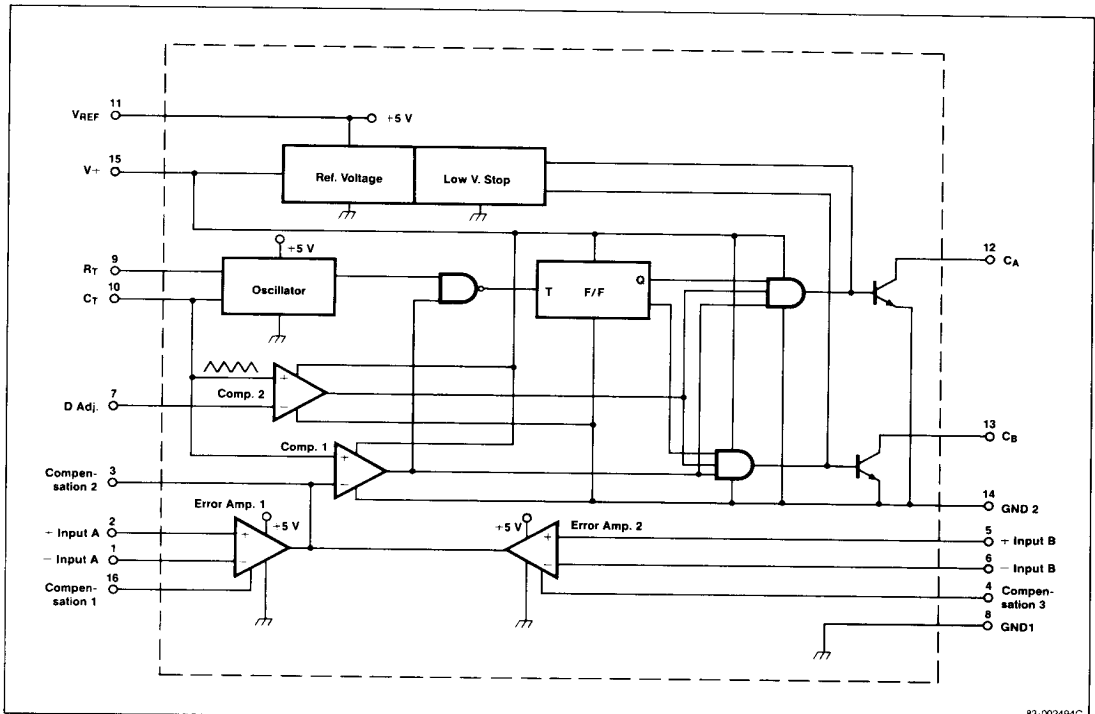

7

Absolute Maximum Ratings

T_A = 25°C

Supply Voltage	30 V
Output Voltage	40 V
Output Current (Each Output)	100 mA
Reference Output Current	40 mA
Total Power Dissipation	800 mW
Operating Temperature Range	-20 to +85°C
Storage Temperature Range	-40 to +125°C

Comment: Stress above those listed under "Absolute Maximum Ratings" may cause permanent damage to the device. This is a stress rating only and functional operation of the device at these or any other conditions above those indicated in the operational sections of this specification is not implied. Exposure to absolute maximum rating conditions for extended periods may affect device reliability.

Recommended Operating Conditions

Parameter	Symbol	Limits			Unit	Test Conditions
		Min.	Typ.	Max.		
Supply Voltage	V+	8	12	16	V	
Output Voltage	V _O		24	32	V	
Output Current	I _O	5	20	40	mA	
Reference Output Current	I _{REF}	0	3	5	mA	
Oscillation Frequency	f _{osc}	20	40	100	kHz	

Electrical Characteristics

V+ = 12 V, T_A = 25°C unless otherwise noted

Parameter	Symbol	Limits			Unit	Test Conditions
		Min.	Typ.	Max.		
Reference Section						
Output Voltage	V _O	4.6	5.0	5.4	V	I _O = 0
Line Regulation	REG _{LN}		13	35	mV	8 V ≤ V+ ≤ 20 V, I _{REF} = 0
Load Regulation	REG _L	-2.5	-10		mV	0 ≤ I _{REF} ≤ 20 mA
Ripple Rejection	RR		60		dB	f = 120 Hz
V _{REF} Drift	ΔV _{REF} /ΔT		200	750	μV/°C	-20°C ≤ T _{OPT} ≤ +85°C
Low Voltage Stop Section						
Startup Voltage	V+ (L to H)		7.5		V	0 ≤ V+ ≤ 12 V
Hysteresis Voltage	V _{HYS}		0.5		V	0 ≤ V+ ≤ 12 V
Oscillator Section						
Maximum Oscillation Frequency	f _{max}	100			kHz	
Initial Accuracy			±5	±10	%	R _T , C _T constant
Temperature Stability			-6	-10	%	-20°C ≤ T _{OPT} ≤ +85°C
Output Voltage (High)	V _{OH}		4		V	
Output Voltage (Low)	V _{OL}		2		V	
Line Frequency Stability			±1	±2	1%	8 V ≤ V+ ≤ 20 V
Error Amplifier 1 Section						
Input Offset Voltage	V _{IO}		±2	±10	mV	
Input Offset Voltage Drift	ΔV _{IO} /ΔT		±4	±10	μV/°C	-20°C ≤ T _{OPT} ≤ +85°C
Input Bias Current	I _B		+1.3	+10	μA	
Large Signal Voltage Gain	A _{VOL}	72	87		dB	
Common Mode Input Voltage	V _{icm}	1.2		4.0	V	
Common Mode Rejection Ratio	CMRR		70		dB	
Small Signal Bandwidth	GBW		2		MHz	A _{v1} = 0 dB, C ₁ = 560 pF, C ₂ = 150 pF

Electrical Characteristics (Cont.)

V+ = 12 V, T_A = 25°C unless otherwise noted

Parameter	Symbol	Limits			Unit	Test Conditions
		Min.	Typ.	Max.		
Error Amplifier 2 Section						
Input Offset Voltage	V _{IO}		±3	±10	mV	
Input Offset Voltage Drift	ΔV _{IO} /ΔT		±3	±10	μV/°C	-20°C ≤ T _{OPT} ≤ +85°C
Input Bias Current	I _b		-1.5	-10	μA	
Large Signal Voltage Gain	A _{VOL}	72	100		dB	
Common Mode Input Voltage	V _{ICM}	0		3	V	
Common Mode Rejection Ratio	CMRR		70		dB	
Small Signal Bandwidth	BBW		1.2		MHz	A _{V2} = 0 dB, C ₃ = 220 pF, C ₄ = 470 pF
Maximum Output Current				1.0	mA	
Dead Time Adjustment Section						
Input Bias Current	I _b		-4.5		μA	
Input Voltage (0% Duty)	V _{IN}		1.35		V	
Input Voltage (100% Duty)	V _{IN}		3.3		V	
Output Section						
Collector to Emitter Voltage	V _{CE}	40			V	I _C = 1 mA
Collector to Emitter Cutoff Current	I _{CEO}			10	μA	V _{CE} = 40 V
Collector Saturation Voltage	V _{CE(SAT)}		0.55	0.7	V	I _C = 20 mA
Rise Time	t _r		80		ns	I _C = 20 mA, V+ = 12 V, R _L = 560 Ω
Fall Time	t _f		70		ns	
Total Standby Current	I _{CCSB}		12	15	mA	V+ = 20 V, I _{REF} = 0

Operating Characteristics

T_A = 25°C

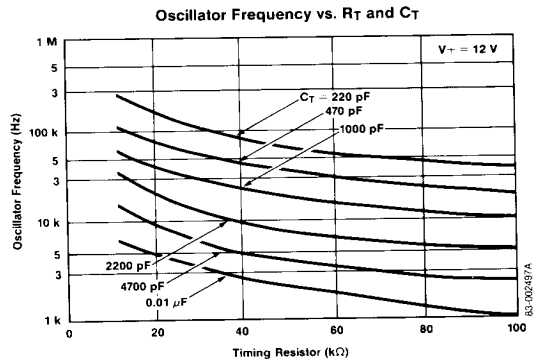
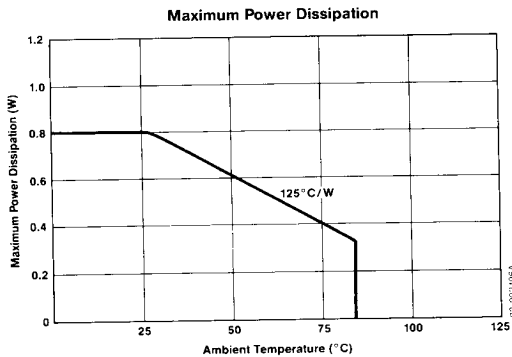

Operating Characteristics (Cont.)

T_A = 25°C

Error Amplifier I, A_{V1} vs. Frequency

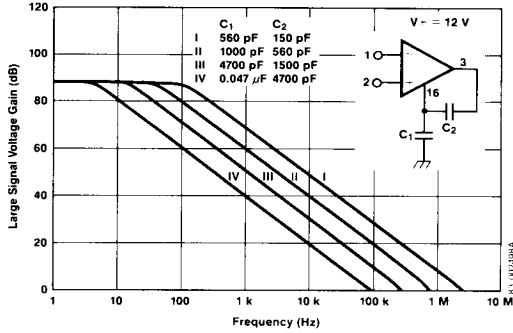

Error Amplifier II, A_{V2} vs. Frequency

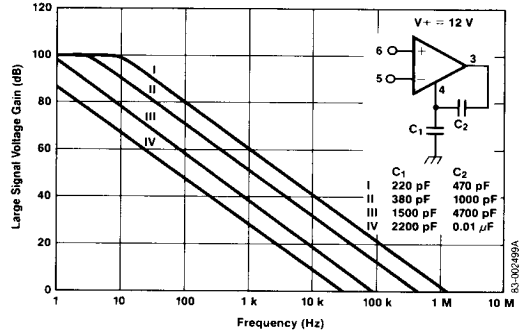

Correct Saturation Voltage vs. Collector Current

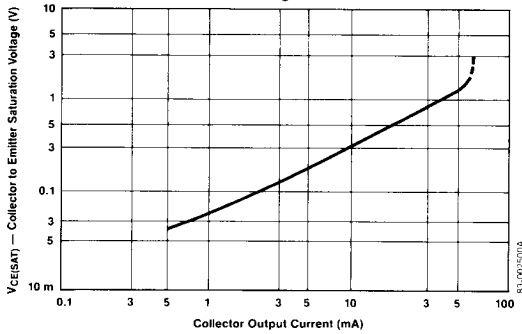

Output Section Rise Time and Fall Time vs. Collector Current

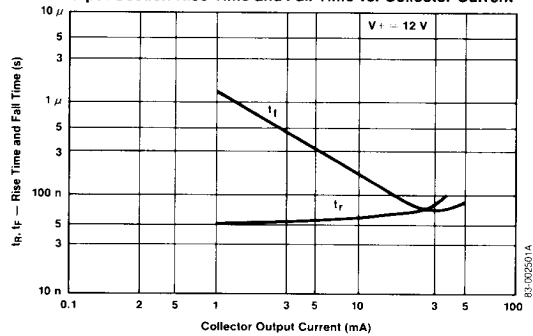

Total Standby Current vs. Supply Voltage

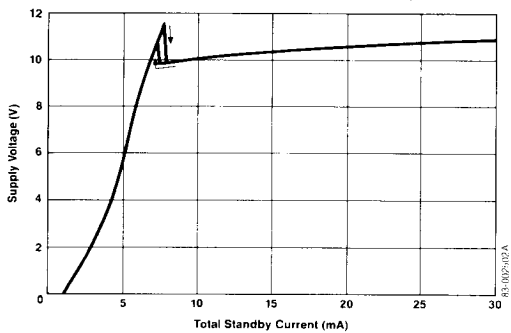

Total Standby Current vs. Ambient Temperature

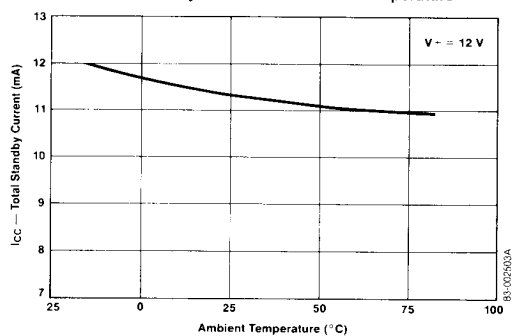

Typical Application

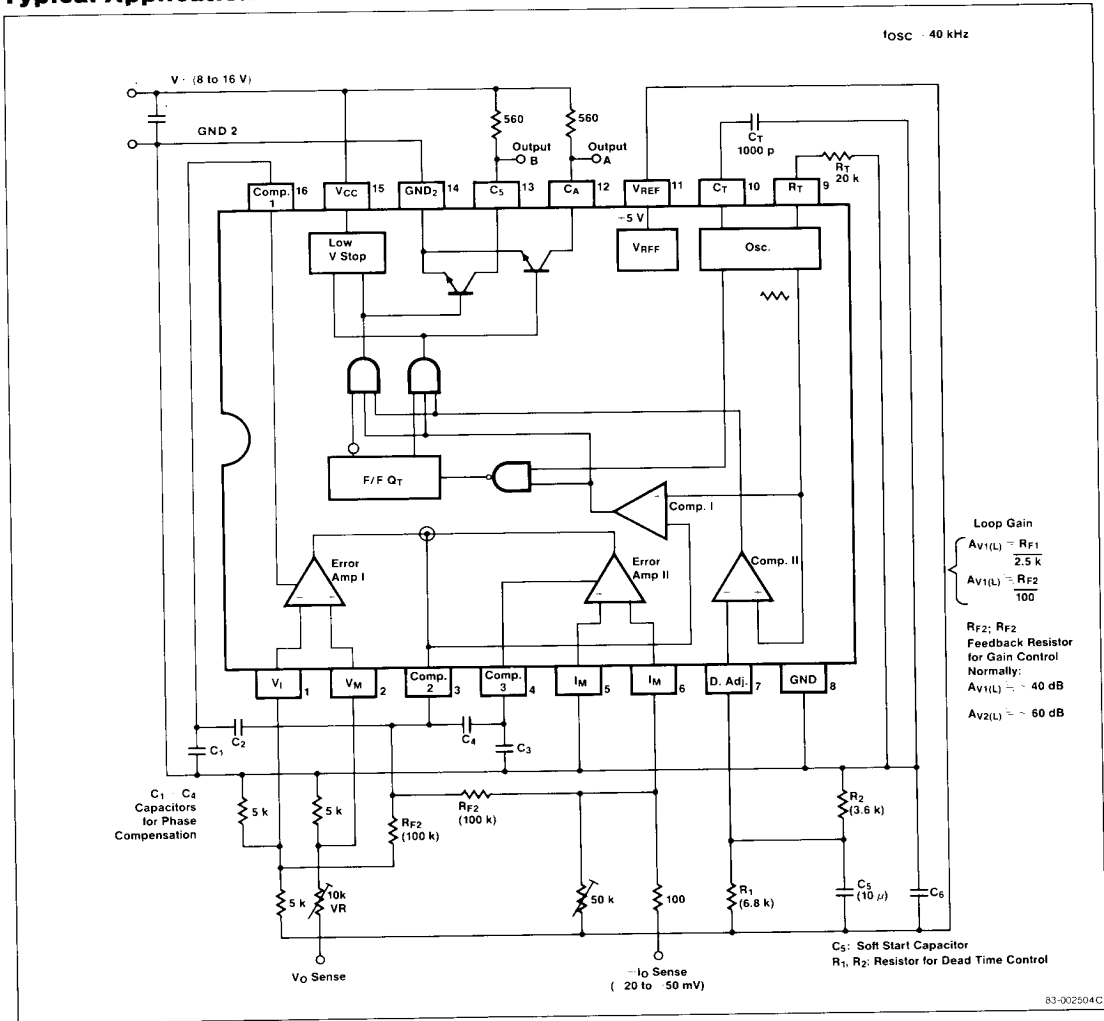

Internal Waveforms (Timing Charts)

